

Operating instruction

FLUXUS F501



UMFLUXUS_F501V1-4EN

FLUXUS is a registered trademark of FLEXIM GmbH.

Operating instruction for
FLUXUS F501
UMFLUXUS_F501V1-4EN, 2022-03-01
Article number: 25387
Copyright (©) FLEXIM GmbH 2022
Subject to change without prior notice.

Table of contents

| | | |
|----------|---|----|
| 1 | Introduction | 7 |
| 2 | Safety instructions | 8 |
| 2.1 | General safety instructions | 8 |
| 2.2 | Intended use | 8 |
| 2.3 | Not intended use | 9 |
| 2.4 | Safety instructions for the user | 9 |
| 2.5 | Safety instructions for the operator | 9 |
| 2.6 | Safety instructions for electrical work | 9 |
| 2.7 | Safety instructions for transport | 10 |
| 2.8 | Recommended procedure in hazardous situations | 10 |
| 3 | General principles | 11 |
| 3.1 | Measurement principle | 11 |
| 3.2 | Measurement arrangements | 14 |
| 3.3 | Acoustic penetration | 16 |
| 3.4 | Undisturbed flow profile | 17 |
| 4 | Product description | 19 |
| 4.1 | Measuring system | 19 |
| 4.2 | Handling concept | 19 |
| 4.3 | Navigation | 20 |
| 4.4 | Keyboard | 21 |
| 5 | Transport and storage | 22 |
| 5.1 | Transport | 22 |
| 5.2 | Storage | 22 |
| 6 | Installation | 23 |
| 6.1 | Transmitter | 23 |
| 6.2 | Transducers | 27 |
| 7 | Connection | 50 |
| 7.1 | Transducers | 50 |
| 7.2 | Power supply | 58 |
| 7.3 | Outputs | 59 |
| 7.4 | Serial interfaces | 61 |
| 8 | Start-up | 62 |
| 8.1 | Start-up settings | 62 |
| 8.2 | Switching on | 63 |
| 8.3 | Program branches | 63 |
| 8.4 | HotCodes | 64 |
| 8.5 | Language | 64 |
| 8.6 | Initialization | 65 |
| 8.7 | Time and date | 65 |
| 8.8 | Instrument information | 66 |
| 8.9 | Interruption of the power supply | 66 |

| | | |
|-----------|---|-----|
| 9 | Measurement | 67 |
| 9.1 | Parameter input | 67 |
| 9.2 | Measurement settings | 72 |
| 9.3 | Start of the measurement | 79 |
| 9.4 | Display of measured values | 82 |
| 9.5 | Execution of special functions | 84 |
| 9.6 | Determination of the flow direction | 84 |
| 9.7 | Stop of the measurement | 84 |
| 10 | Troubleshooting | 85 |
| 10.1 | Problems with the measurement | 86 |
| 10.2 | Measuring point selection | 86 |
| 10.3 | Maximum acoustic contact | 86 |
| 10.4 | Application-specific problems | 86 |
| 10.5 | Significant deviations of the measured values | 87 |
| 10.6 | Problems with the totalizers | 87 |
| 11 | Maintenance and cleaning | 88 |
| 11.1 | Maintenance | 88 |
| 11.2 | Cleaning | 89 |
| 11.3 | Calibration | 89 |
| 12 | Dismounting and disposal | 90 |
| 12.1 | Dismounting | 90 |
| 12.2 | Disposal | 90 |
| 13 | Outputs | 91 |
| 13.1 | Installation of a binary output | 91 |
| 13.2 | Activation of a binary output as pulse output | 92 |
| 14 | Data logger | 94 |
| 14.1 | Activation/Deactivation of the data logger | 94 |
| 14.2 | Setting the storage rate | 94 |
| 14.3 | Configuration of the data logger | 95 |
| 14.4 | Measurement with activated data logger | 96 |
| 14.5 | Deletion of measured values | 97 |
| 14.6 | Information relating the data logger | 97 |
| 15 | Data transmission | 98 |
| 15.1 | FluxDiagReader/FluxDiag | 98 |
| 15.2 | Terminal program | 98 |
| 15.3 | Transmission parameters | 100 |
| 15.4 | Data format | 101 |
| 15.5 | Data structure | 101 |

| | | |
|--------------|---|-----|
| 16 | Advanced functions | 103 |
| 16.1 | Totalizers | 103 |
| 16.2 | NoiseTrek parallel beam mode (option) | 104 |
| 16.3 | Upper limit of the flow velocity | 104 |
| 16.4 | Cut-off flow | 105 |
| 16.5 | Profile correction | 106 |
| 16.6 | Uncorrected flow velocity | 106 |
| 16.7 | Diagnosis with the help of the snap function | 107 |
| 16.8 | Modification of the limit for the inner pipe diameter | 108 |
| 16.9 | Activation of a binary output as alarm output | 108 |
| 16.10 | Behavior of the alarm outputs | 111 |
| 17 | SuperUser mode | 114 |
| 17.1 | Activation/deactivation | 114 |
| 17.2 | Defining flow parameters | 114 |
| 17.3 | Limit of the signal amplification | 116 |
| 17.4 | Upper limit of the sound speed | 117 |
| 17.5 | Detection of long measurement failures | 118 |
| 17.6 | Number of decimal places of the totalizers | 118 |
| 17.7 | Manual reset of the totalizers | 119 |
| 17.8 | Display of the totalizer sum | 119 |
| 17.9 | Display of the last valid measured value | 119 |
| 17.10 | Displays during the measurement | 120 |
| 18 | Settings | 121 |
| 18.1 | Dialogs and menus | 121 |
| 18.2 | Measurement settings | 123 |
| 18.3 | Libraries | 125 |
| 18.4 | Contrast settings | 127 |
| 18.5 | Program code | 127 |
| | | |
| Annex | | |
| A | Menu structure | 129 |
| B | Units of measurement | 137 |
| C | Reference | 140 |
| D | Conformity declarations | 143 |



1 Introduction

This operating instruction has been written for users operating the ultrasonic flowmeter FLUXUS. It contains important information about the measuring equipment, how to handle it correctly, and how to avoid damages. Read the safety instructions carefully. Make sure you have read and understood this operating instruction before using the measuring equipment.

Any work on the measuring equipment has to be carried out by authorized and qualified personnel in order to detect and avoid possible risks and dangers.

Presentation of warnings

This operating instruction contains warnings marked as follows:

| | |
|---|---|
| Danger! | |
|  | Type and source of danger danger with high level of risk, which if not avoided, can lead to death or serious injuries → measures of prevention |
| Warning! | |
|  | Type and source of danger danger with medium level of risk, which if not avoided, can lead to death or serious injuries → measures of prevention |
| Caution! | |
|  | Type and source of danger danger with low level of risk, which if not avoided, can lead to minor or moderate injuries → measures of prevention |
| Important! | |
| This text contains important information which should be observed to avoid material damage. | |
| Notice! | |
| This text contains important information about the handling of the measuring equipment. | |

Storage of the operational manual

The operating instruction must permanently be available at the place where the measuring equipment is used. It must always be available to the user.

User comments

All reasonable effort has been made to ensure the correctness of the content of this operating instruction. If you however find some erroneous information or miss information, please inform us.

We will be grateful for any suggestions and comments regarding the concept and your experience working with the measuring equipment. If you have any suggestions about improving the documentation and particularly this operating instruction, please let us know so that we can consider your comments for future reprints.

Copyright

The contents of this operating instruction are subject to changes without prior notice. All rights reserved. No part of this operating instruction may be reproduced in any form without FLEXIM's written permission.

2 Safety instructions







2.1 General safety instructions

Prior to any work, read the operating instruction carefully and in full.

Failure to comply with the instructions, in particular with the safety instructions, poses a risk to health and can lead to material damages. For further information, contact FLEXIM.

During installation and operation of the measuring equipment, observe the ambient and installation conditions specified in the documentation.

Explanation of symbols on the transmitter:

| symbol | explanation |
|---|-----------------------------------|
|  | direct current |
|  | connection to ground |
|  | ground conductor terminal |
|  | warning of voltage |
|  | observe the operating instruction |
|  | Attention! |

The measuring equipment has to be checked for proper condition and operational safety before each use. If troubles or damages have occurred during installation or operation of the measuring equipment, please inform FLEXIM.

It is not allowed to make unauthorized modifications or alterations to the measuring equipment.

The personnel has to be suitably trained and experienced for the work.

2.2 Intended use

The measuring equipment is intended for the measurement of fluid properties in closed pipes. By means of connected transducers, the transit times of the ultrasonic signals in the fluid and the pipe are measured and evaluated.

The transmitter uses these values to calculate the sought quantities, e.g., volumetric flow rate, mass flow rate, heat quantity, density and concentration. Through comparison with the values stored in the transmitter further physical quantities can be determined. The physical quantities are provided via configurable outputs and the display.

- All instructions of this operating instruction have to be observed to ensure intended use.
- Any use beyond or other than the intended use is not covered by warranty and can present a danger. Any damage arising from not intended use shall be solely the liability of the operator or user.
- The measurement is carried out without direct contact to the fluid in the pipe. The flow profile is not influenced.
- The transducers are fixed to the pipe using the supplied transducer mounting fixture.
- If an extension cable is required to connect the transducers to the transmitter, a junction box can be used (optional). Observe the safety instructions in the operating instruction. For the technical data of the junction box, see technical specification.
- Observe the operating conditions, e.g., environment, voltage ranges. For the technical data of the transmitter, transducers and accessories, see technical specification.

2.3 Not intended use

Not intended use in terms of a misuse means:

- any work on the measuring equipment without observing all instructions in this operating instruction
- use of transmitter, transducer and accessories combinations not intended by FLEXIM
- installation of the transmitter, transducers and accessories in explosive atmospheres they are not approved for
- any work on the measuring equipment (e.g., installation, dismantling, connection, start-up, operation, service and maintenance) carried out by unauthorized and untrained personnel
- storage, installation and operation of the measuring equipment outside the specified ambient conditions, see technical specification

2.4 Safety instructions for the user

Any work on the transmitter has to be carried out by authorized and qualified personnel. Observe the safety instructions in the operating instruction. For the technical data of the transmitter, transducers and accessories, see technical specification.

- Observe the safety and accident prevention regulations applicable on the site of operation.
- Only use the supplied mounting fixtures and transducers as well as the intended accessories.
- Always wear the required personal protective equipment.

2.5 Safety instructions for the operator

- The operator shall qualify the personnel to perform their assigned tasks. The operator shall provide the required personal protective equipment and oblige the personnel to wear it. It is recommended to risk assess the workplace.
- Besides the safety instructions in this operating instruction, the health, safety and environment regulations applicable for the range of application of the transmitter, transducers and accessories have to be observed.
- With the exceptions stated in chapter 11, the measuring equipment is maintenance-free. Any components and spare parts may only be replaced by FLEXIM. The operator shall carry out periodic checks for changes or damages that can present a danger. For further information, contact FLEXIM.
- Observe the specifications for the installation and connection of the transmitter, transducers and accessories, see chapter 6 and 7.

2.6 Safety instructions for electrical work

- Prior to any work on the transmitter (e.g., installation, dismantling, connection, service and maintenance), the transmitter has to be disconnected from the power supply. It is not sufficient to remove the internal fuse of the instrument, see section 7.2.
- Electrical work may only be carried out if there is enough space.
- Open the transmitter in safe ambient conditions only (e.g., air humidity < 90 %, no conductive pollution, no explosive atmosphere). Otherwise, additional protective measures have to be taken.
- The degree of protection of the transmitter is only ensured if all cables are tightly fitted using cable glands and the housing is firmly screwed.
- The condition and tight fit of the electrical connections have to be checked at regular intervals.
- When connecting the transmitter to the power supply, an appropriate equipment switch according to IEC 60947-1 and IEC 60947-3 has to be installed as disconnecting device. The equipment switch has to disconnect all live wires. The ground conductor connection must not be interrupted. The equipment switch has to be easily accessible and clearly marked as a disconnecting device for the transmitter. It should be located near the transmitter. If the transmitter is used in an explosive atmosphere, the equipment switch has to be installed outside the explosive atmosphere. If this is not possible, it has to be installed in the least hazardous area.
- The connection may only be made to networks up to overvoltage category II. When connecting the inputs and outputs as well as the power supply, observe the installation instructions, in particular the terminal assignment, see chapter 7.
- The front plate must not be removed, see Fig. 2.1. The transmitter does not contain any components to be maintained by the user. For repair and service work, please contact FLEXIM.
- Observe the safety and accident prevention regulations for electrical systems and equipment.

Fig. 2.1: Transmitter FLUXUS F501

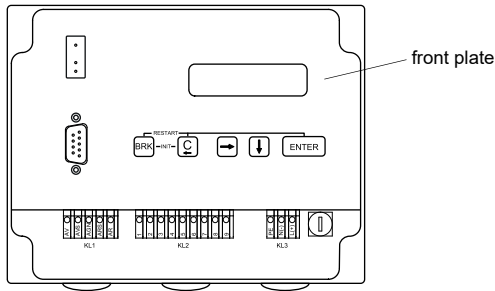

2.7 Safety instructions for transport

- If you detect a transport damage when unpacking the delivery, please contact the supplier or FLEXIM immediately.
- The transmitter is a sensitive electronic measuring instrument. Avoid shocks or impacts.
- Handle the transducer cable with care. Avoid excessive bending or buckling. Observe the ambient conditions.
- Select a solid surface to put the transmitter, transducers and accessories on.
- The transmitter, transducers and accessories have to be properly packed for transport:
 - Use, if possible, the original packaging by FLEXIM or an equivalent cardboard box.
 - Position the transmitter, transducers and accessories in the middle of the cardboard box.
 - Fill any voids with appropriate packaging material (e.g., paper, foam, bubble wrap).
 - Protect the cardboard box against humidity.

2.8 Recommended procedure in hazardous situations

Fire fighting measures

- If possible, disconnect the transmitter from the power supply.
- Prior to extinguishing, protect any electrical parts that are not affected by the fire (e.g., using a cover).
- Select a suitable extinguishing agent. Avoid, if possible, conductive extinguishing agents.
- Observe the applicable minimum distances. The minimum distances differ depending on the used extinguishing agent.

3 General principles

In the ultrasonic flow measurement, the flow velocity of the fluid in a pipe is determined. Further physical quantities are derived from the flow velocity and from additional physical quantities, if necessary.

3.1 Measurement principle

The flow velocity of the fluid is measured using the transit time difference correlation principle.

3.1.1 Terms

Flow profile

Distribution of flow velocities over the cross-sectional pipe area. For an optimal measurement, the flow profile has to be fully developed and axisymmetrical. The shape of the flow profile depends on whether the flow is laminar or turbulent and is influenced by the conditions at the inlet of the measuring point.

Reynolds number Re

Coefficient describing the turbulence behavior of a fluid in the pipe. The Reynolds number Re is calculated from the flow velocity, the kinematic viscosity of the fluid and the inner pipe diameter.

If the Reynolds number exceeds a critical value (usually approx. 2300, if the fluid flows in a pipe), a transition from a laminar flow to a turbulent flow takes place.

Laminar flow

A flow without any turbulence. There is no mixing between the parallel flowing layers of the fluid.

Turbulent flow

A flow with turbulences (swirling of the fluid). In technical applications, the flow in the pipe is mostly turbulent.

Transition range

The flow is partly laminar and partly turbulent.

Sound speed c

Speed of the propagating sound. The sound speed depends on the mechanical properties of the fluid or the pipe material. In pipe materials and other solid materials, a distinction is made between the longitudinal and transversal sound speed. For the sound speed of some fluids and materials, see annex C.

Flow velocity v

Average value of all flow velocities of the fluid over the cross-sectional pipe area.

Acoustic calibration factor k_a

$$k_a = \frac{c_\alpha}{\sin \alpha}$$

The acoustic calibration factor k_a is a transducer parameter which results from the sound speed c within the transducer and the angle of incidence. According to Snell's law of refraction, the angle of propagation in the adjoining fluid or pipe material is:

$$k_a = \frac{c_\alpha}{\sin \alpha} = \frac{c_\beta}{\sin \beta} = \frac{c_\gamma}{\sin \gamma}$$

Fluid mechanics correction factor k_{Re}

With the fluid mechanics calibration factor k_{Re} , the measured value of the flow velocity in the area of the sound beam is converted into the value of the flow velocity across the whole cross-sectional pipe area. In case of a fully developed flow profile, the fluid mechanics calibration factor only depends on the Reynolds number and the roughness of the inner pipe wall. The fluid mechanics calibration factor is recalculated by the transmitter for each new measurement.

Volumetric flow rate \dot{V}

$$\dot{V} = v \cdot A$$

The volume of the fluid that passes through the pipe per unit time. The volumetric flow rate is calculated from the product of the flow velocity v and the cross-sectional pipe area A .

Mass flow rate \dot{m}

$$\dot{m} = \dot{V} \cdot \rho$$

The mass of the fluid that passes through the pipe per unit time. The mass flow rate is calculated from the product of the volumetric flow rate \dot{V} and the density ρ .

3.1.2 Measurement of the flow velocity in the TransitTime mode

The signals are emitted and received by 2 transducers alternatively in and against the flow direction. If the fluid is flowing, the signals propagating in the fluid are displaced with the flow.

Caused by this displacement, the sound path of the signal in flow direction is reduced and the signal against the flow direction is increased, see Fig. 3.1 and Fig. 3.2.

This causes a change in the transit times. The transit time of the signal in flow direction is shorter than the transit time against the flow direction. The transit time difference is proportional to the average flow velocity.

The average flow velocity of the fluid is calculated as follows:

$$v = k_{Re} \cdot k_a \cdot \frac{\Delta t}{2 \cdot t_v}$$

where

- v – average flow velocity of the fluid
- k_{Re} – fluid mechanics calibration factor
- k_a – acoustic calibration factor
- Δt – transit time difference
- t_v – transit time in the fluid

Fig. 3.1: Sound path of the signal in the flow direction

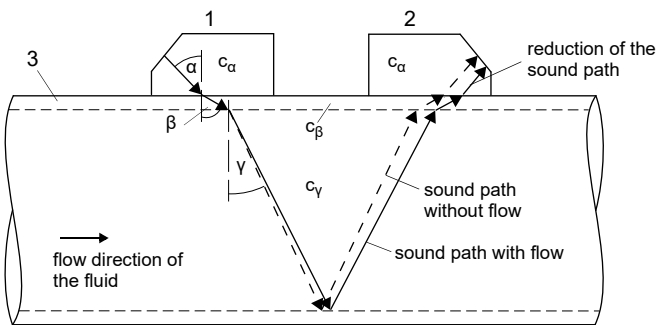

- c – sound speed
- 1 – transducer (emitter)
- 2 – transducer (receiver)
- 3 – pipe wall

Fig. 3.2: Sound path of the signal against the flow direction

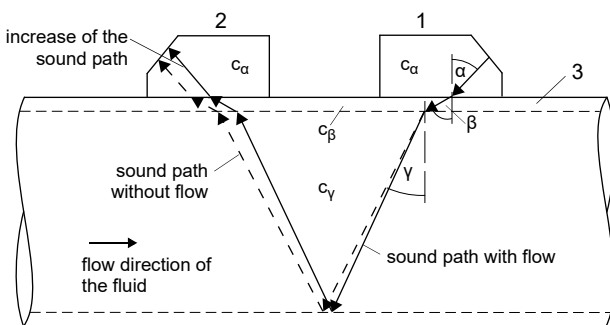

- c – sound speed
- 1 – transducer (emitter)
- 2 – transducer (receiver)
- 3 – pipe wall

Fig. 3.3: Transit time difference Δt

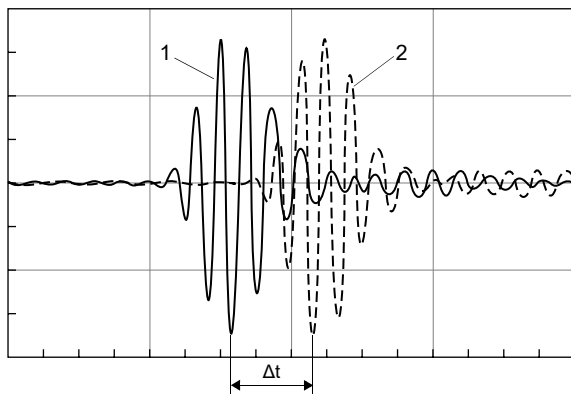

- 1 – signal in the flow direction
- 2 – signal against the flow direction

3.1.3 Measurement of the flow velocity in the NoiseTrek parallel beam mode (option)

Pipes with a small pipe diameter or fluids which strongly attenuate the ultrasonic signal can cause a reduction of the transit time in the fluid with the result that the signal quality is no longer sufficient. In this case the NoiseTrek parallel beam mode has to be used.

The NoiseTrek parallel beam mode uses the presence of gas bubbles and/or solid particles in the fluid.

Ultrasonic signals are sent into the fluid at short intervals, reflected by the gas bubbles and/or the solids particles and again received. This leads to a better signal quality. The transducers are mounted in parallel on the pipe at a small distance, see Fig. 3.4.

A measurement in TransitTime mode is not possible when working with this measurement arrangement.

Fig. 3.4: Measurement arrangement in the NoiseTrek parallel beam mode

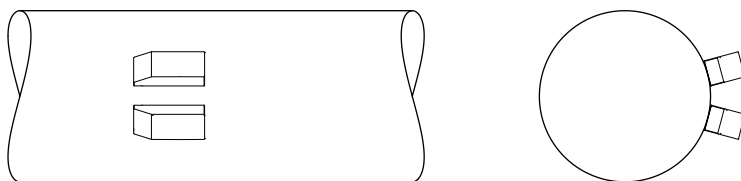

The transit time difference Δt of 2 consecutive ultrasonic signals is determined. It behaves proportionately to the distance the gas bubble/solid particle is covering between 2 consecutive pulses and thus, to the average flow velocity of the fluid, see Fig. 3.5.

Fig. 3.5: Measurement of the flow velocity in the NoiseTrek parallel beam mode

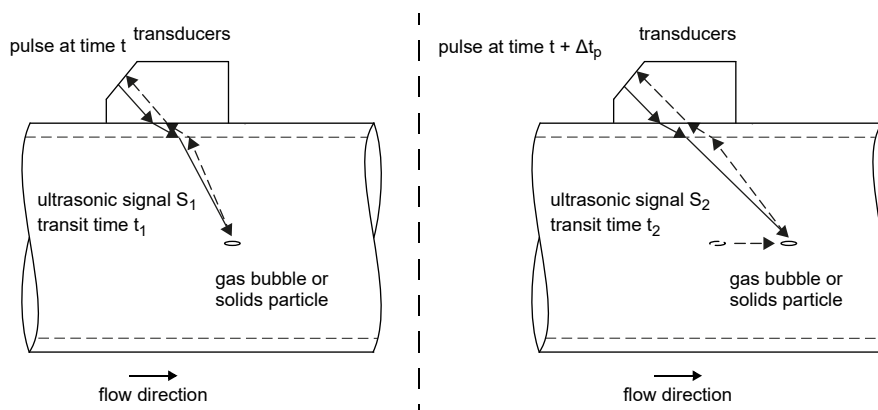

The average flow velocity of the fluid is calculated as follows:

$$v = k_{Re} \cdot k_a \cdot \frac{\Delta t}{2 \cdot \Delta t_p}$$

where

- v – average flow velocity of the fluid
- k_{Re} – fluid mechanics calibration factor
- k_a – acoustic calibration factor
- Δt_p – time difference between 2 consecutive pulses
- Δt – transit time difference of ultrasonic signals S_1 and S_2 ($\Delta t = t_2 - t_1$)

3.2 Measurement arrangements

3.2.1 Terms

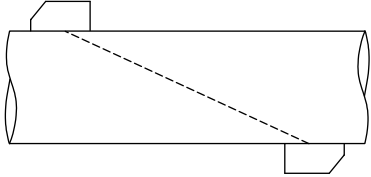
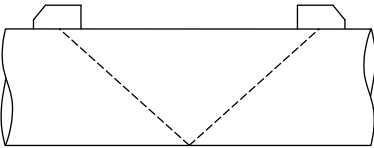
| Diagonal arrangement | Reflection arrangement |
|--|--|
| The transducers are mounted on opposite sides of the pipe. | The transducers are mounted on the same side of the pipe. |
|  |  |

Sound path

The distance covered by the ultrasonic signal after crossing the pipe once. The number of the sound paths is:

- odd if the measurement is carried out in diagonal arrangement
- even if the measurement is carried out in reflection arrangement

Beam

The path covered by the ultrasonic signal between the transducers, i.e., the transducer emitting the ultrasonic signal and the transducer receiving it. One beam consists of 1 or several sound paths.

Fig. 3.6: Diagonal arrangement with 1 beam and 3 sound paths

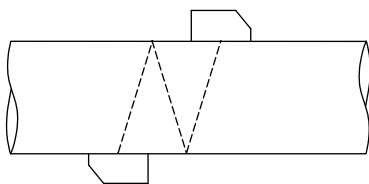
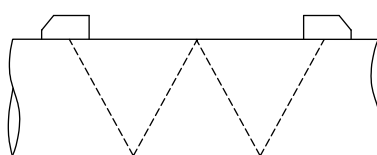
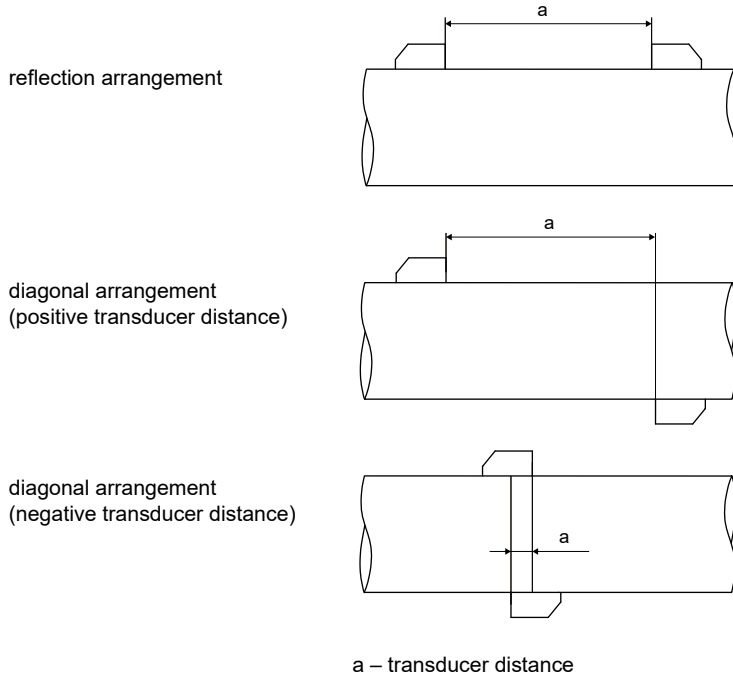

Fig. 3.7: Reflection arrangement with 1 beam and 4 sound paths



Transducer distance

The transducer distance is measured between the inner edges of the transducers.



Sound beam plane

plane, containing sound paths or beams

Fig. 3.8: 2 sound paths in 1 plane

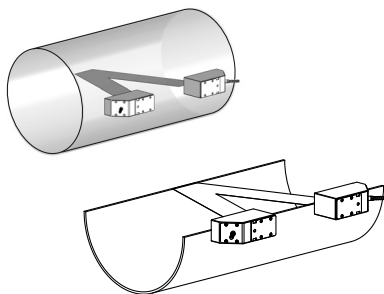

3.2.2 Examples

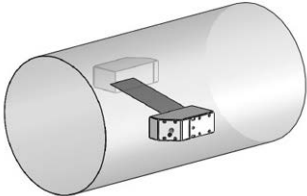
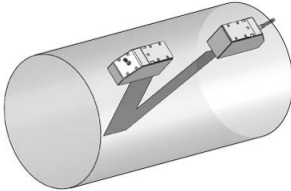
| Diagonal arrangement with 1 beam | Reflection arrangement with 1 beam |
|---|---|
| <p>1 transducer pair 1 sound path</p>  | <p>1 transducer pair 2 sound paths</p>  |

3.3 Acoustic penetration

The pipe has to be acoustically penetrable at the measuring point. The acoustic penetration is given when pipe and fluid do not attenuate the sound signal so strongly that it is completely absorbed before reaching the second transducer.

The attenuation caused by the pipe and the fluid depends on:

- kinematic viscosity of the fluid
- proportion of gas bubbles and solids in the fluid
- deposits on the inner pipe wall
- pipe material

The following requirements have to be met at the measuring point:

- the pipe is always completely filled
- no solid deposits in the pipe
- no bubble formation in the pipe

Notice!

Even bubble-free fluids can form gas bubbles when the fluid expands, e.g., before pumps and after great cross-section extensions.

Observe the following notes on the selection of the measuring point:

Horizontal pipe

Select a measuring point where the transducers can be mounted laterally on the pipe, allowing the sound waves to propagate horizontally in the pipe. Thus, solids on the bottom of the pipe or gas bubbles in the pipe's upper part are prevented from influencing the propagation of the signal, see Fig. 3.9 and Fig. 3.10.

Fig. 3.9: Recommended transducer mounting position

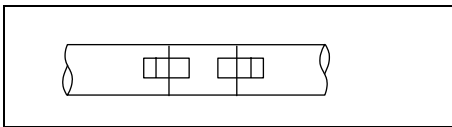
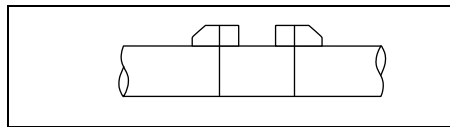

Fig. 3.10: Disadvantageous transducer mounting position



Vertical pipe

Select the measuring point at a pipe location where the fluid flows upward. The pipe has to be completely filled, see Fig. 3.11 and Fig. 3.12.

Fig. 3.11: Recommended transducer mounting position

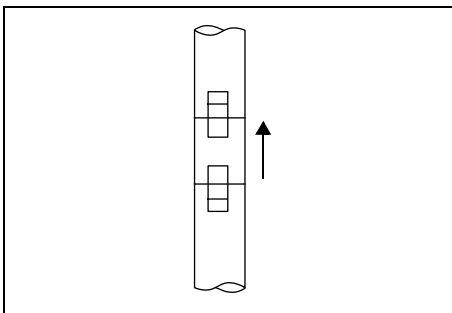
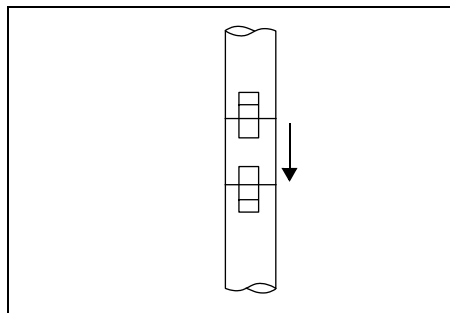

Fig. 3.12: Disadvantageous transducer mounting position



Free inlet or outlet pipe section

Select the measuring point at a pipe section where the pipe cannot run empty, see Fig. 3.13 and Fig. 3.14.

Fig. 3.13: Recommended transducer mounting position

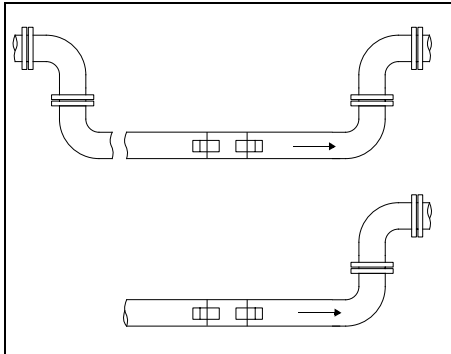
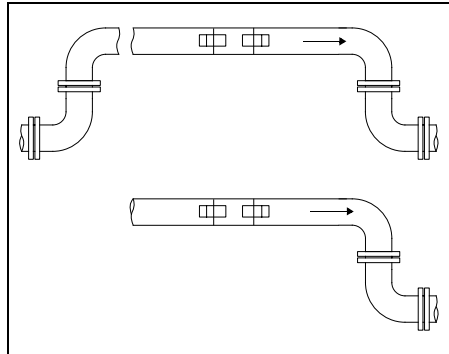

Fig. 3.14: Disadvantageous transducer mounting position



3.4 Undisturbed flow profile

Some flow elements (e.g., elbows, valves, pumps, reducers) distort the flow profile in their vicinity. The axisymmetrical flow profile in the pipe needed for correct measurement is no longer given. A careful selection of the measuring point helps to reduce the impact of disturbance sources.

It is most important that the measuring point is chosen at a sufficient distance from any disturbances. Only then it can be assumed that the flow profile in the pipe is fully developed. However, measuring results can be obtained even if the recommended distance to disturbances cannot be met for practical reasons (no ideal inflow, see section 16.5).

The recommended straight inlet and outlet pipe lengths for different types of flow disturbance sources are shown in the examples in Tab. 3.1.

Tab. 3.1: Recommended distance from disturbance sources
D – nominal pipe diameter at the measuring point
l – recommended distance between disturbance source and transducer position

| | |
|--|----------------------|
| disturbance source: 90° elbow | |
| inlet: $l \geq 10 D$ | outlet: $l \geq 5 D$ |
| | |
| disturbance source: 2 × 90° elbows on different planes | |
| inlet: $l \geq 40 D$ | outlet: $l \geq 5 D$ |
| | |

Tab. 3.1: Recommended distance from disturbance sources
D – nominal pipe diameter at the measuring point
l – recommended distance between disturbance source and transducer position

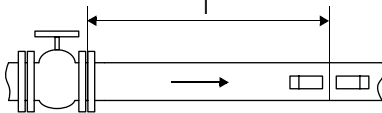
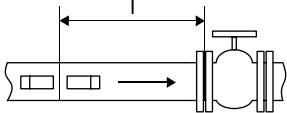
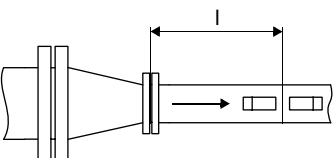
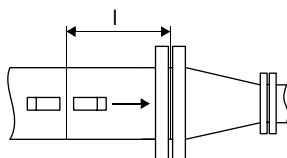
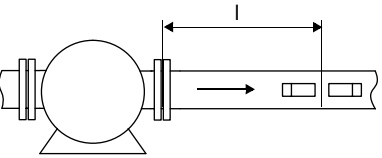
| | |
|---|---|
| disturbance source: valve | |
| inlet: $l \geq 40 D$ | outlet: $l \geq 5 D$ |
|  |  |
| disturbance source: reducer | |
| inlet: $l \geq 10 D$ | outlet: $l \geq 5 D$ |
|  |  |
| disturbance source: pump | |
| inlet: $l \geq 20 D$ | |
|  | |

4 Product description

4.1 Measuring system

The measurement system consists of a transmitter, the ultrasonic transducers and the pipe on which the measurement is carried out, see Fig. 4.1.

Fig. 4.1: Example for a measurement arrangement

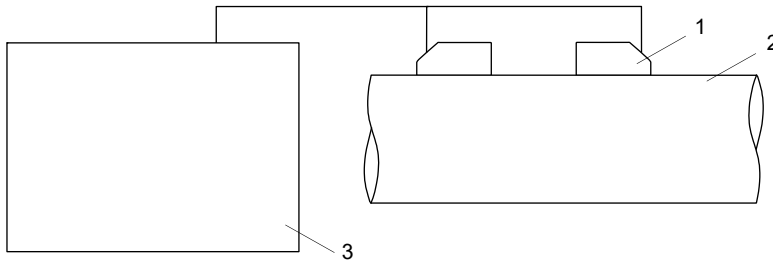

- 1 – transducer
- 2 – pipe
- 3 – transmitter

The ultrasonic transducers are mounted on the pipe. They send and receive ultrasonic signals through the fluid.

The transmitter controls the measuring cycle, eliminates noise signals and analyzes useful signals. The measured values can be displayed, used for calculations and transmitted by the transmitter.

4.2 Handling concept

The selected program branch is displayed in angle brackets and capital letters, see Fig. 4.2. The complete name of the selected program branch is displayed in the lower line.

Select a program branch with key and . Press ENTER.

- par (Parameter)
- mea (Measuring)
- opt (Output Options)
- sf (Special Funct.)

Fig. 4.2: Command panel of the transmitter

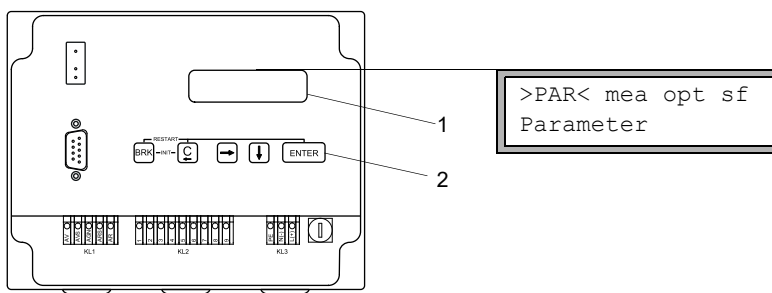

- 1 – display
- 2 – keyboard

For a description of the individual program branches, see Tab. 4.1.

Tab. 4.1: Description of the program branches

| program branch | description |
|----------------|---|
| Parameter | Before starting a measurement, the transducer, pipe and fluid parameters have to be entered in the program branch <code>Parameter</code> . |
| Measuring | After the input of the transducer distance, the measurement is started in the program branch <code>Measuring</code> . |
| Output Options | Channel-related settings such as determination of the physical quantity, unit of measurement and parameters for the transmission of measured values are set in the program branch <code>Output Options</code> . |
| Special Funct. | Includes global settings which are not directly related to the measurement. |

4.3 Navigation

4.3.1 Scroll lists

If a vertical arrow \updownarrow is displayed, the menu item contains a scroll list. The current list item is displayed in the lower line.

```
Special Funct.  $\updownarrow$ 
SYSTEM settings
```

- Press key \rightarrow and \downarrow to scroll and select a list item in the lower line.
- Press ENTER.

Some menu item contain a horizontal scroll list in the lower line. The selected list item is displayed in angle brackets and capital letters.

```
Lining
no          YES
```

- Press key \rightarrow and \downarrow to scroll and select a list item in the lower line.
- Press ENTER.

Some menu items contain a horizontal scroll list in the upper line. The selected list item is displayed in angle brackets and capital letters. The current value of the list item is displayed in the lower line.

```
R1=FUNC< typ mode
Function      MAX
```

- Press key \rightarrow to scroll and select a list item in the upper line.
- Press key \downarrow to scroll and select a value for the selected list item in the lower line.
- Press ENTER.

4.3.2 Input fields

```
OUTER DIAMETER
100.0      mm
```

- Enter the value with keys \rightarrow and \downarrow , see Tab. General functions.
- Press ENTER.



4.4 Keyboard

The keyboard has 5 keys: ENTER, BRK, C,  and .



Tab. 4.2: General functions

| | |
|-----------------|---|
| ENTER | confirmation of selection or input |
| BRK + C | INIT: When switching on the transmitter press these 2 keys simultaneously to execute the initialization, see section 8.8 |
| BRK + C + ENTER | Reset: press these 3 keys simultaneously to correct a malfunction. The reset has the same effect as a restart of the transmitter. Stored data are not affected. |
| BRK | interruption of the measurement and selection of the main menu Be careful not to stop a current measurement by inadvertently pressing key BRK. |



Tab. 4.3: Navigation

| | |
|---|--|
|  | scroll to the right or up through a scroll list |
|  | scroll to the left or down through a scroll list |

Tab. 4.4: Input of numbers

| | |
|---|--|
|  | move the cursor to the right |
|  | scroll through the numbers above the cursor |
| C | move the cursor to the left If the cursor is on the left margin: <ul style="list-style-type: none"> • an already edited value will be reset to the value which was stored previously • an unedited value will be deleted. If the entered value is not valid, an error message will be displayed. Press ENTER and enter a correct value. |

Tab. 4.5: Input of text

| | |
|---|--|
|  | move the cursor to the right |
|  | scroll through the characters above the cursor |
| C | reset all characters to the last stored entry |

5 Transport and storage

Caution!



When packaging, the transmitter can fall down.

There is a danger of crushing body parts or damaging the measuring equipment.

- Secure the transmitter against falling during packaging. Wear the required personal protective equipment. Observe the applicable rules.

Caution!



When lifting, the center of gravity of the transmitter can be displaced within the cardboard box. The transmitter can fall down.

There is a danger of crushing body parts or damaging the measuring equipment.

- Secure the transmitter against falling during transport. Wear the required personal protective equipment. Observe the applicable rules.

5.1 Transport

The measuring equipment must be packaged properly for transport, see section 2.7. For weight indications of the transmitter and the transducers, see technical specification.

5.2 Storage

The transmitter and the transducers have to be stored in a dry place.

6 Installation

Warning!



Installation, connection and start-up by unauthorized and unqualified personnel

This may result in personal or material damage or other dangerous situations.

→ Any work on the transmitter has to be carried out by authorized and qualified personnel.

Caution!



Safety and accident prevention regulations for electrical systems and equipment

Failure to observe these regulations may lead to death or severe injury.

→ Observe the safety and accident prevention regulations for electrical systems and equipment.

Caution!



Touching hot or cold surfaces

This may result in injuries (e.g., thermal damages).

→ Observe the ambient conditions at the measuring point during installation. Wear the required personal protective equipment. Observe the applicable rules.

6.1 Transmitter

The command panel can be accessed by opening the housing cover.

Fig. 6.1: Command panel of the transmitter

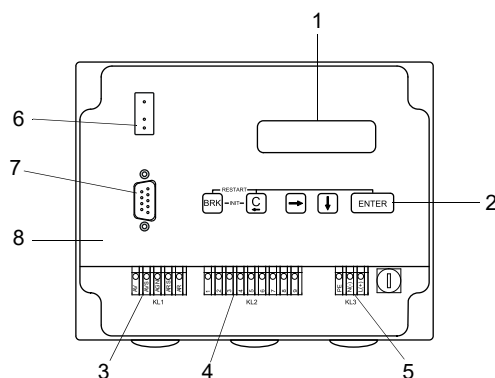

- 1 – LCD display, backlight
- 2 – keyboard
- 3 – transducers
- 4 – outputs
- 5 – power supply
- 6 – transducer module socket
- 7 – RS232 service interface
- 8 – front plate

6.1.1 Opening and closing the housing

Opening

Important!

Do not use objects which may damage the housing gasket to open the cover housing.

- Loosen the screws of the transmitter housing, see Fig. 6.2
- Open the housing cover of the transmitter.
- Remove the protection foils on the window of the housing (inside and outside), see Fig. 6.2 as well as on the transmitter display, see Fig. 6.1.

Closing

- Close the housing cover.
- Tighten the screws of the transmitter housing, see Fig. 6.2.

Fig. 6.2: Transmitter

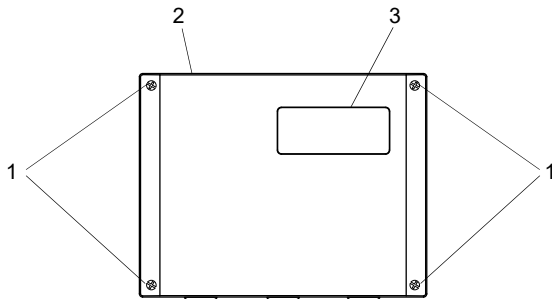

- 1 – screws
- 2 – housing cover
- 3 – window of the housing cover

6.1.2 Installation of the transmitter

6.1.2.1 Wall installation

- Loosen the screws of the transmitter housing, see Fig. 6.2.
- Open the housing cover of the transmitter.
- Fix the transmitter with 4 screws to the wall, see Fig. 6.3.

Fig. 6.3: Transmitter (dimensions in mm)

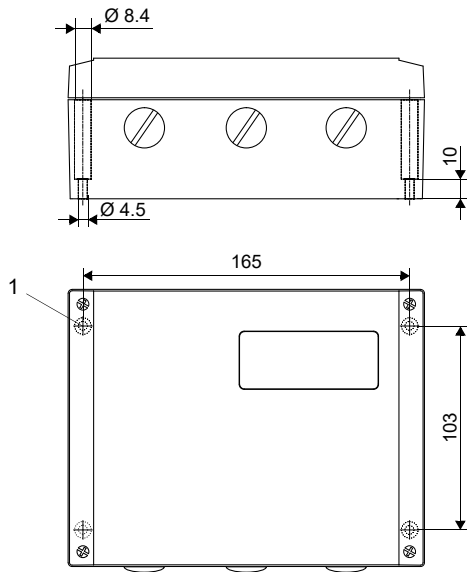

1 – fixing holes for wall mounting

6.1.2.2 Pipe installation

Important!

The pipe has to be sufficiently stable to withstand the pressure exerted by the transmitter and the shackles.

Installation on a 2" pipe

The pipe mounting kit is fixed to the pipe using a shackle, see Fig. 6.4.

- Fix the pipe mounting plate (2) and the instrument mounting plate (3) to the pipe using the nuts (4) and the shackle (1).
- Use the screws to fix the transmitter to the instrument mounting plate.

Fig. 6.4: Pipe mounting kit

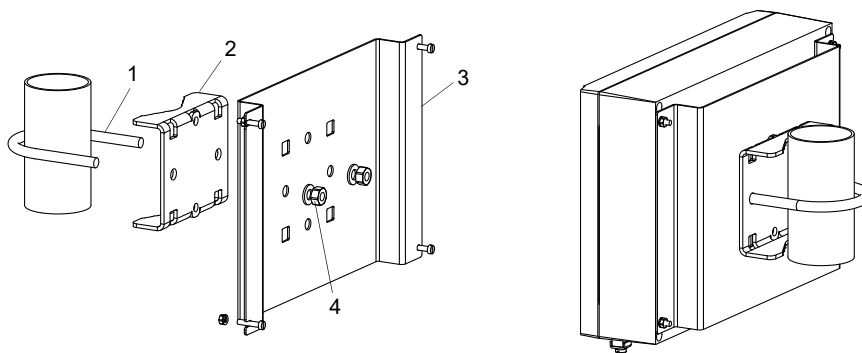

- 1 – shackle
- 2 – pipe mounting plate
- 3 – instrument mounting plate
- 4 – nut

Installation on a pipe > 2"

The pipe mounting kit is fixed to the pipe by using tension straps, see Fig. 6.5.

Caution!



The edge of the tension strap is very sharp.

Risk of injury!

→ Debur sharp edges.

→ Wear the required personal protective equipment. Observe the applicable rules.

- Insert the tension straps (3) into the holes of the pipe mounting plate (1) and the instrument mounting plate (2).
- Fix the pipe mounting plate and the instrument mounting plate to the pipe using the tension straps.
- Use the screws to fix the transmitter to the instrument mounting plate.

Fig. 6.5: Pipe installation with tension straps

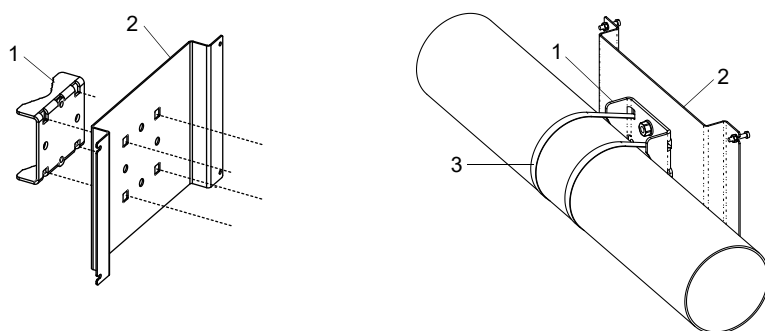

- 1 – pipe mounting plate
- 2 – instrument mounting plate
- 3 – tension strap

6.2 Transducers

6.2.1 Preparation

6.2.1.1 Measuring point selection

The correct selection of the measuring point is crucial for achieving reliable measurement results and a high measurement accuracy.

A measurement on a pipe is possible if:

- the ultrasound propagates with a sufficiently high amplitude
- the flow profile is fully developed

The correct selection of the measuring point and the correct transducer positioning guarantee that the sound signal will be received under optimum conditions and evaluated correctly.

Because of the variety of applications and the different factors that influence the measurement, there is no standard solution for the transducer positioning.

The measurement is influenced by the following factors:

- diameter, material, lining, wall thickness and shape of the pipe
- fluid
- gas bubbles in the fluid
- Avoid measuring points in the vicinity of distorted or defective areas of the pipe or in the vicinity of welds.
- Avoid measuring points with deposit formation in the pipe.
- Make sure the pipe surface at the selected measuring point is even.
- Select the location of the transmitter within the transducer cable range.
- The ambient temperature at the measuring point has to be within the operating temperature range of the transmitter and the transducers, see technical specification.

6.2.1.2 Pipe preparation

Caution!



Contact with grinding dust

This may result in injuries (e.g., breathing difficulties, skin reactions, eye irritations).

→ Wear the required personal protective equipment. Observe the applicable rules.

Important!

The pipe has to be sufficiently stable to withstand the pressure exerted by the transducers and the tension straps.

Notice!

Observe the selection criteria of pipe and measuring point.

Rust, paint or deposits on the pipe absorb the sound signal. A good acoustic contact between the pipe and the transducers is obtained as follows:

- Clean the pipe at the selected measuring point.
 - If present, the paint layer has to be smoothed by grinding. The paint does not need to be removed completely.
 - Remove rust or loose paint.
- Use coupling foil or apply a bead of acoustic coupling compound along the center line of the contact surface of the transducers.
- Observe that there must be no air pockets between the transducer contact surface and the pipe wall.

6.2.1.3 Selection of the measurement arrangement

Diagonal arrangement with 1 beam

Reflection arrangement with 1 beam

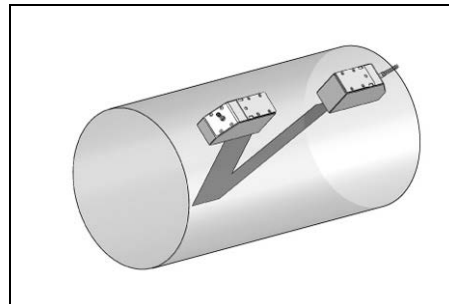
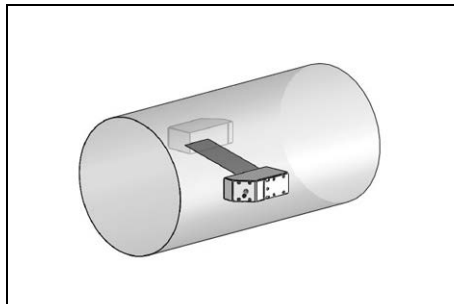

- wider flow velocity and sound speed range compared to the reflection arrangement
- use in the presence of deposits on the inner pipe wall or with strongly attenuating gases or liquids (only 1 sound path)

- smaller flow velocity and sound speed range compared to the diagonal arrangement
- transverse flow effects are compensated because the beam crosses the pipe in 2 directions
- higher accuracy of measurement because the accuracy increases with the number of sound paths

If the measuring point is situated near an elbow, the following measurement arrangements are recommended for the selection of the sound beam plane.

Vertical pipes

Horizontal pipes

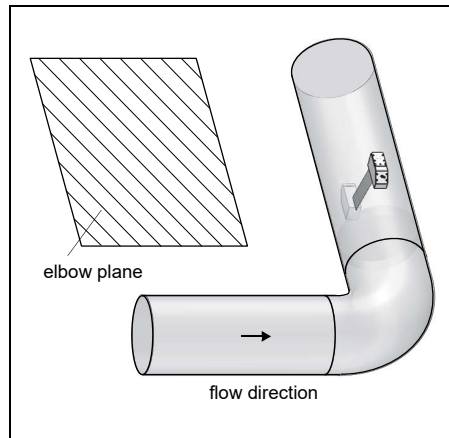
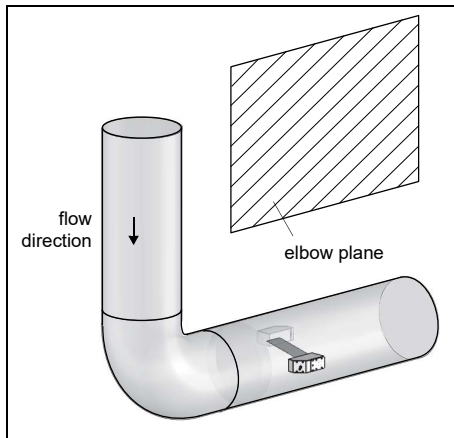

- The sound beam plan is selected in an angle of 90° to the elbow plane. The elbow is upstream of the measuring point.

- The sound beam plane is selected in an angle of $90^\circ \pm 45^\circ$ to the elbow plane. The elbow is upstream of the measuring point.

Bidirectional measurements

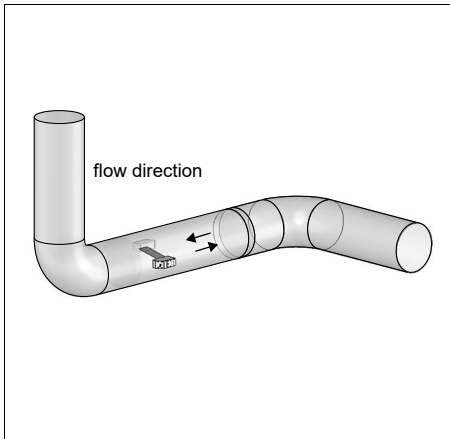

- The sound beam plane is selected according to the nearest elbow (horizontal or vertical, depending on the pipe orientation, see above).

6.2.2 Installation of the transducers

6.2.2.1 Orientation of the transducers and determination of the transducer distance

Observe the orientation of the transducers. If the transducers have been mounted properly, the engravings on the transducers form an arrow, see Fig. 6.6. The transducer cables show in opposite directions.

The transducer distance is measured between the inner edges of the transducers.

Fig. 6.6: Orientation of the transducers and transducer distance

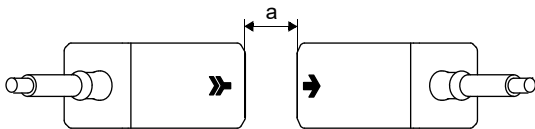

a – transducer distance

- Select the installation instructions that correspond to the supplied transducer mounting fixture.

6.2.2.2 Transducer arrangement

The transducer mounting with mounting rails can have various arrangements:

Fig. 6.7: Transducer arrangement in mounting rails

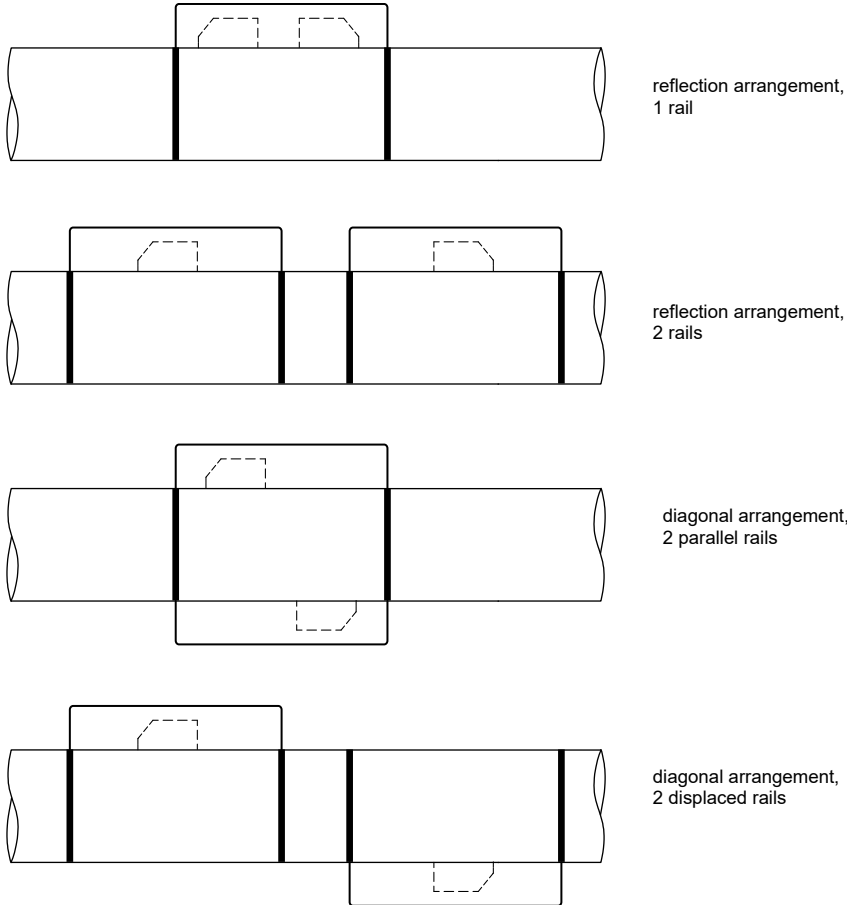

6.2.2.3 Mounting with Variofix L, PermaRail

Scope of delivery

2 × Variofix L

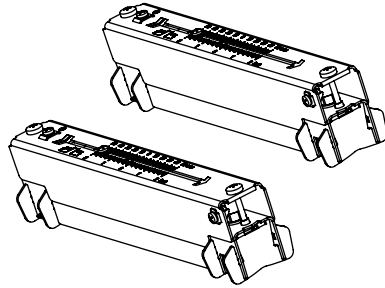

1 × transducer pair

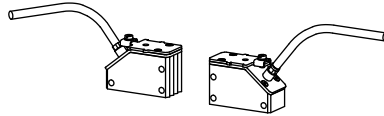

4 × quick release clasp with tension strap

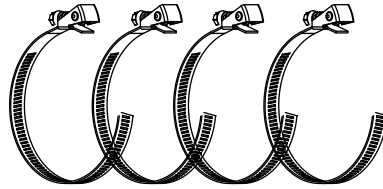

or

4 × band clamp clasp with tension strap

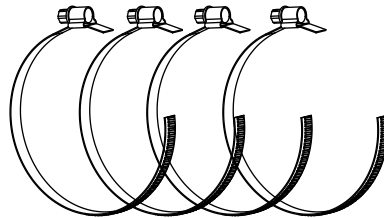

or

4 × ratchet clasp and tension strap coil

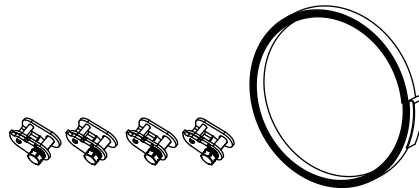

Mounting

When measuring in diagonal arrangement, the transducer mounting fixtures are mounted on opposite sides of the pipe, see Fig. 6.8. When measuring in reflection arrangement, the transducer mounting fixtures are mounted on the same side of the pipe, see Fig. 6.9.

When measuring in diagonal arrangement with 2 beams in displaced X arrangement, 4 transducer mounting fixtures have to be mounted. When measuring in reflection arrangement and small transducer distance, only 1 transducer mounting fixture has to be mounted, see Tab. 6.1.

Tab. 6.1: Approximate values for the mounting of both transducers in a Variofix L

| transducer frequency (3rd character of the technical type) | length of the rail [mm] | transducer distance [mm] |
|---|-------------------------|--------------------------|
| F | 368 | < 94 |
| G, H, K (****LI*) | 368 | < 94 |
| G, H, K (except ****LI*) | 348 | < 89 |
| M, P (Lamb wave transducers) M, P (shear wave transducers) | 234 | < 84 < 100 |
| Q | 176 | < 69 |

In the following, the mounting of 2 transducer mounting fixtures in reflection arrangement is described (1 transducer mounting fixture for each transducer).

Fig. 6.8: Transducer mounting fixture Variofix L (diagonal arrangement)

Fig. 6.9: Transducer mounting fixture Variofix L (reflection arrangement)

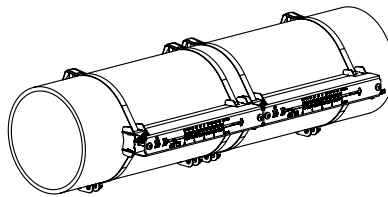
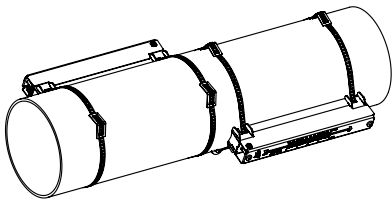

Overview of the mounting steps

- **step 1**
dismounting of the transducer mounting fixture Variofix L
- **step 2**
fixing the clasps to the tension straps
- **step 3**
fixing the tension strap to the pipe
- **step 4**
fixing the rail to the pipe
- **step 5**
installation in the transducer mounting fixture Variofix L

Step 1: Dismounting of the transducer mounting fixture Variofix L

- Disassemble the transducer mounting fixture Variofix L, see Fig. 6.10.

Fig. 6.10: Dismounting of the transducer mounting fixture Variofix L

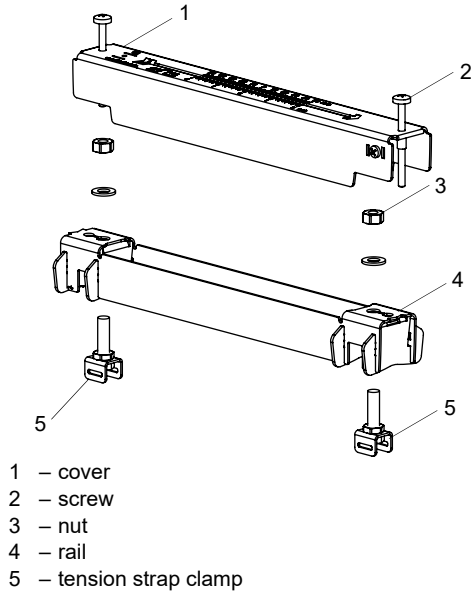
**Step 2: Fixing the clasps to the tension straps**

- Select the installation instructions according to the supplied clasp:

Band clamp clasp

The clasp is fixed to the tension strap, see Fig. 6.11.

Quick release clasp

The clasp is fixed to the tension strap, see Fig. 6.12.

- Cut the tension strap to length (pipe circumference + at least 120 mm).

Fig. 6.11: Band clamp clasp with tension strap

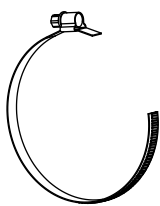
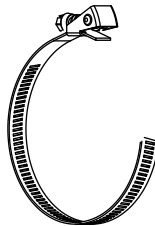

Fig. 6.12: Quick release clasp with tension strap



Ratchet clasp

- Cut the tension strap to length (pipe circumference + at least 120 mm).

Caution!



The edge of the tension strap is very sharp.

Risk of injury!

→ Debur sharp edges.

→ Wear the required personal protective equipment. Observe the applicable rules.

- Insert approx. 100 mm of the tension strap into part (1) and (2) of the ratchet clasp, see Fig. 6.13 a.
- Bend the tension strap.
- Insert the tension strap into part 1 of the ratchet clasp, see Fig. 6.13 b.
- Tighten the tension strap.
- Repeat the steps for the second tension strap.

Fig. 6.13: Ratchet clasp with tension strap

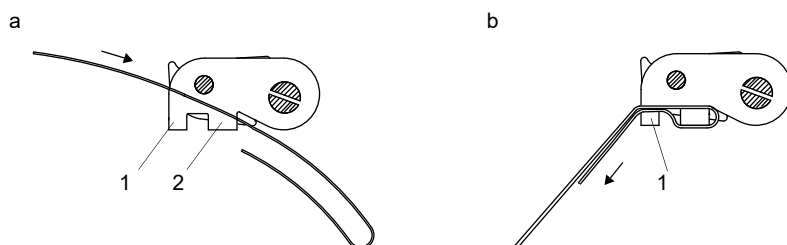

Step 3: Fixing the tensions strap to the pipe

One tension strap is fixed to the pipe, see Fig. 6.14. The second tension strap is mounted later.

Fig. 6.14: Tension strap with tension strap clamp and metal spring on the pipe

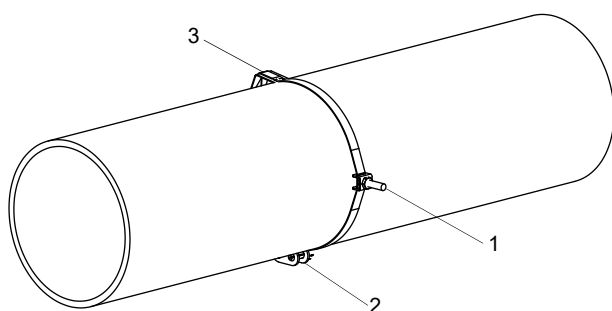

- 1 – tension strap clamp
- 2 – clasp
- 3 – metal spring

Select the installation instructions according to the supplied clasp:

Band clamp clasp

- Insert the tension strap into the tension strap clamp, see Fig. 6.15.
- Position the clasp and the tension strap clamp on the pipe, see Fig. 6.14. On a horizontal pipe, mount the tension strap clamp on the side of the pipe, if possible.
- Place the tension strap around the pipe and insert it into the clasp, see Fig. 6.17.
- Tighten the tension strap.
- Tighten the clasp screw.

Quick release clasp

- Insert the tension strap into the tension strap clamp and the metal spring, see Fig. 6.15 and Fig. 6.16.
- Position the clasp, the tension strap clamp and the metal spring on the pipe, see Fig. 6.14:
 - on a horizontal pipe, mount the tension strap clamp on the side of the pipe, if possible
 - mount the metal spring opposite to the tension strap clamp

Fig. 6.15: Tension strap with tension strap clamp

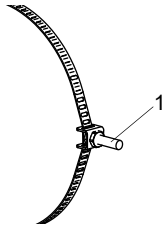

1 – tension strap clamp

Fig. 6.16: Tension strap with quick release clasp and metal spring

1 – clasp screw
2 – metal spring

Fig. 6.17: Tension strap with band clamp clasp



1 – clasp screw

- Place the tension strap around the pipe and insert it into the clasp, see Fig. 6.16.
- Tighten the tension strap.
- Tighten the clasp screw.

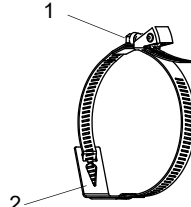
Ratchet clasp

- Insert the tension strap into the tension strap clamp and the metal spring, see Fig. 6.18. The metal spring does not have to be mounted on:
 - steel pipes
 - pipes with an outer pipe diameter < 80 mm
 - pipes that are not subjected to significant temperature fluctuations
- Position the ratchet clasp, tension strap clamp and metal spring (if necessary) on the pipe, see Fig. 6.14:
 - on a horizontal pipe, mount the tension strap clamp on the side of the pipe, if possible
 - mount the metal spring (if necessary) opposite to the tension strap clamp
- Place the tension strap around the pipe and pass it through the slot of the clasp screw, see Fig. 6.19.
- Tighten the tension strap.
- Cut off the protruding tension strap, see Fig. 6.19.

Caution!**The edge of the tension strap is very sharp.**

Risk of injury!

→ Debur sharp edges.

→ Wear the required personal protective equipment. Observe the applicable rules.

- Tighten the clasp screw.

Notice!

In order to release the screw and the tension strap, press the lever down, see Fig. 6.19.

Fig. 6.18: Tension strap with metal spring and clamp



- 1 – metal spring
- 2 – tension strap clamp

Fig. 6.19: Ratchet clasp with tension strap

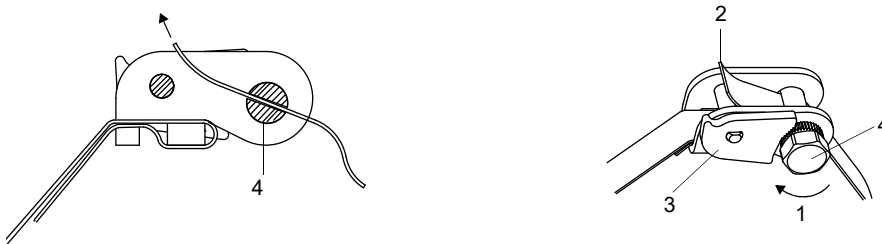

- 1 – sense of rotation
- 2 – edge
- 3 – lever
- 4 – clasp screw with slot

Step 4: Fixing the rail to the pipe

- Place the tension strap clamp (2) in the rail, see Fig. 6.20. Observe the orientation of the tension strap clamp.
- Tighten the nut of the tension strap clamp (2) slightly.
- Screw the rail to tension strap clamp (1), see Fig. 6.21.
- Tighten the nut of tension strap clamp (1), but not too firmly in order not to damage the tension strap.

Fig. 6.20: Rail with tension strap clamp

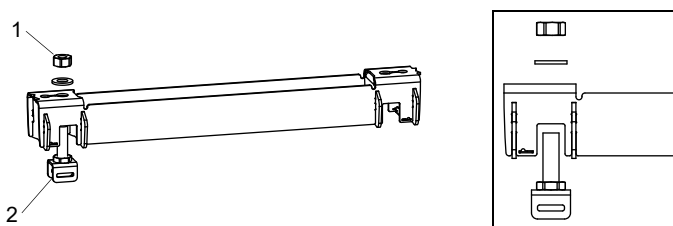

- 1 – nut
- 2 – tension strap clamp

Fig. 6.21: Rail, mounted on one side of the pipe

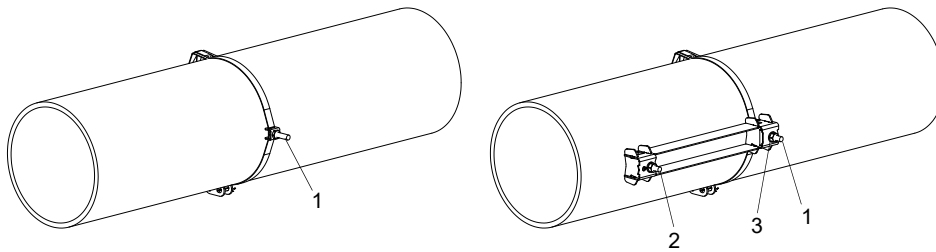

- 1 – tension strap clamp
- 2 – tension strap clamp
- 3 – nut

- Select the installation instructions according to the supplied clasp:

Band clamp clasp

- Insert the tension strap into the tension strap clamp (2), see Fig. 6.22.
- Place the tension strap around the pipe and insert it into the clasp, see Fig. 6.23.
- Tighten the tension strap.
- Tighten the clasp screw.
- Tighten the nut of the tension strap clamp (2), but not too firmly in order not to damage the tension strap, see Fig. 6.22.

Fig. 6.22: Rail on the pipe

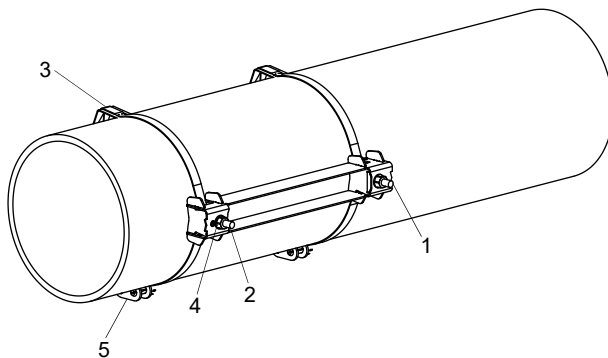

- 1 – tension strap clamp
- 2 – tension strap clamp
- 3 – metal spring
- 4 – nut
- 5 – clasp

Quick release clasp

- Insert the tension strap into the tension strap clamp (2) and the metal spring, see Fig. 6.22 and Fig. 6.24.
- Place the tension strap around the pipe and insert it into the clasp.
- Position the metal spring opposite to the tension strap clamp (2).
- Tighten the tension strap.
- Tighten the clasp screw.
- Tighten the nut of the tension strap clamp (2), but not too firmly in order not to damage the tension strap, see Fig. 6.22.

Fig. 6.23: Tension strap with band clamp clasp



1 – clasp screw

Fig. 6.24: Tension strap with quick release clasp and metal spring

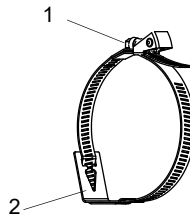

1 – clasp screw
2 – metal spring

Ratchet clasp

- Insert the tension strap into the tension strap clamp (2) and the metal spring, see Fig. 6.22 and Fig. 6.25. The metal spring does not have to be mounted on:
 - steel pipes
 - pipes with an outer pipe diameter < 80 mm
 - pipes that are not subjected to significant temperature fluctuations
- Position the ratchet clasp, tension strap clamp (2) and metal spring (if necessary) on the pipe:
- Position the metal spring opposite to the tension strap clamp.
- Place the tension strap around the pipe and pass it through the slot of the clasp screw, see Fig. 6.26.
- Tighten the tension strap.
- Cut off the protruding tension strap, see Fig. 6.26.

Caution!



The edge of the tension strap is very sharp.

Risk of injury!

→ Debur sharp edges.

→ Wear the required personal protective equipment. Observe the applicable rules.

- Tighten the clasp screw.
- Tighten the nut of the tension strap clamp (2), but not too firmly in order not to damage the tension strap, see Fig. 6.22.

Notice!

In order to release the screw and the tension strap, press the lever down, see Fig. 6.19.

Fig. 6.25: Tension strap with metal spring and clamp

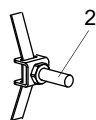
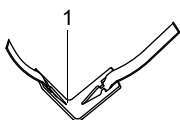

1 – metal spring
2 – tension strap clamp

Fig. 6.26: Ratchet clasp with tension strap

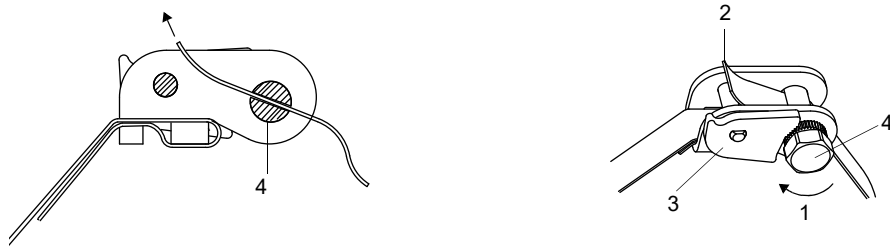

- 1 – sense of rotation
- 2 – edge
- 3 – lever
- 4 – clasp screw with slot

- Repeat the steps to fix the second rail, see Fig. 6.27.

Fig. 6.27: Pipe with 2 rails

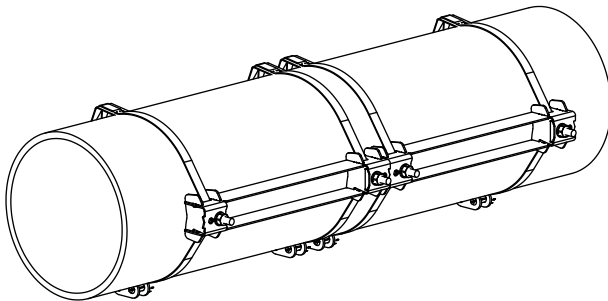

Step 5: Installation in the transducer mounting fixture Variofix L

- Press the transducers firmly into the transducer mounting fixture in the covers until the transducers are tightly fixed. The transducer cables show in opposite directions, see Fig. 6.28.

Notice!
The arrows on the transducers and the covers have to point in the same direction.

Fig. 6.28: Installation of the transducers in the covers

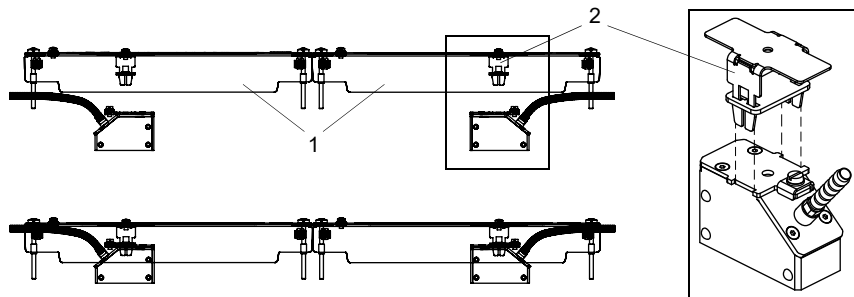

- 1 – cover
- 2 – transducer clamping fixture

- Adjust the transducer distance displayed by the transmitter, see Fig. 6.29.
- Fix the transducer cables with the strain relief clamp to protect them from mechanical strain, see Fig. 6.29.
- Stick coupling foil (or some coupling compound for a short-term installation) on the contact surface of the transducers. The coupling foil can be fixed to the contact surface with some coupling compound.
- Put the covers with the transducers on the rails.
- Correct the transducer distance, if necessary.

Fig. 6.29: Adjustment of the transducer distance

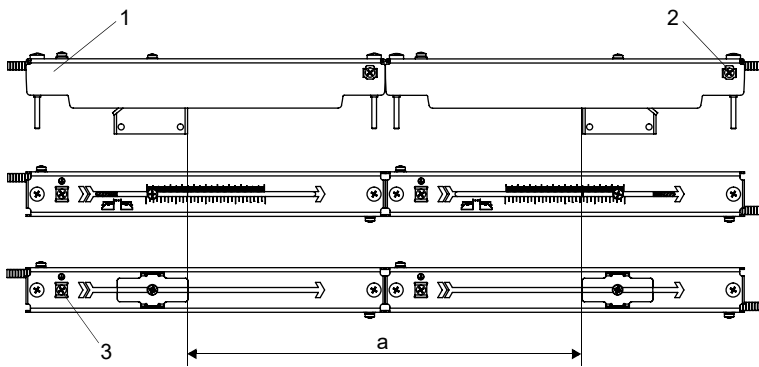

- 1 – cover
- 2 – strain relief clamp
- 3 – equipotential bonding terminal
- a – transducer distance

Notice!

Make sure that the coupling foil remains on the contact surface of the transducers. For information concerning the coupling foil, see the safety data sheet. In case a safety data sheet is required, contact FLEXIM.

- Tighten the cover screws, see Fig. 6.30.

Fig. 6.30: Variofix L with transducers on the pipe

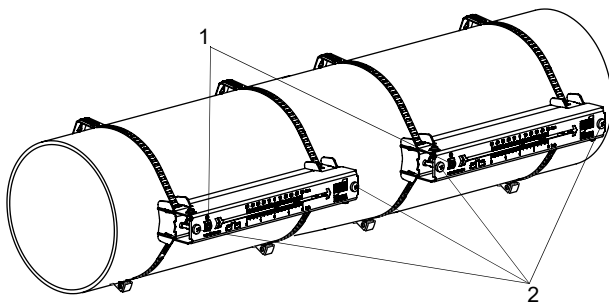

- 1 – equipotential bonding terminal
- 2 – cover screws

6.2.2.4 Mounting with Variofix C

Scope of delivery

1 × Variofix C

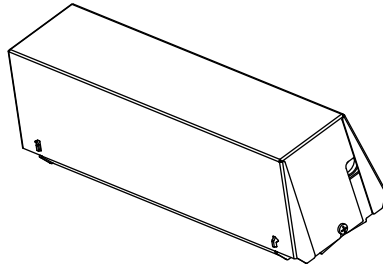

1 × transducer pair

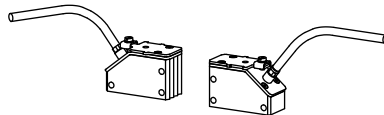

1 × tension strap coil

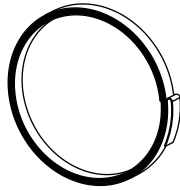

2 × ratchet clasp



Mounting

When measuring in reflection arrangement, 1 transducer mounting fixture is mounted laterally on the pipe, see Fig. 6.31. When measuring in diagonal arrangement, 2 transducer mounting fixtures are mounted on opposite sides of the pipe, see Fig. 6.32.

In the following, the installation of 1 transducer mounting fixture in reflection arrangement is described.

Fig. 6.31: Transducer mounting fixture Variofix C (reflection arrangement)

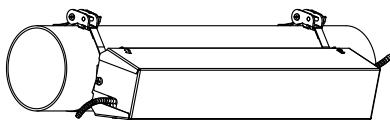
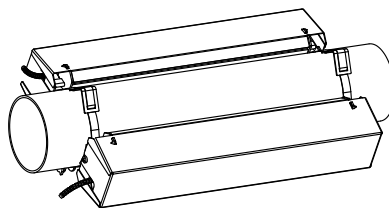

Fig. 6.32: Transducer mounting fixture Variofix C (diagonal arrangement)



Overview of the mounting steps

- **step 1**
dismounting of the transducer mounting fixture Variofix C
- **step 2**
mounting the rail
- **step 3**
installation of the transducers in the transducer mounting fixture Variofix C

Step 1: Dismounting of the transducer mounting fixture Variofix C

- Disassemble the transducer mounting fixture Variofix C.

In order to remove the cover from the rail, bend the outer sides of the cover outwards, see Fig. 6.33.

In order to remove the spring clip from the rail, slide it over the indentation on the rail and lift it off, see Fig. 6.34.

Fig. 6.33: Removal of the cover

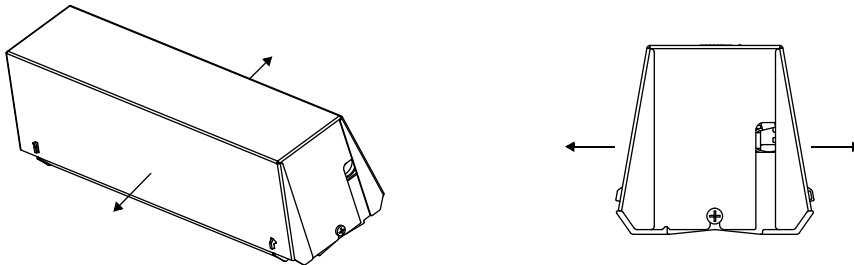
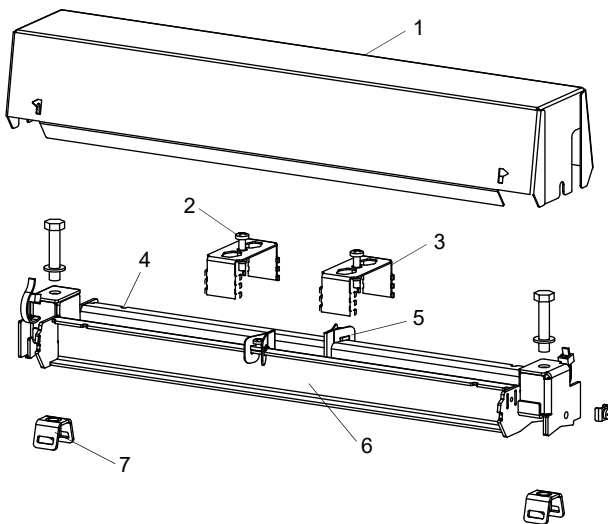

Fig. 6.34: Dismounting of the transducer mounting fixture Variofix C



- 1 – cover
- 2 – tensioning screw
- 3 – spring clip
- 4 – indentation
- 5 – spacing element
- 6 – rail
- 7 – tension strap clamp

Step 2: Mounting the rail

- Select the installation instructions according to the supplied clasp:

Mounting of the rail without a clasp

- Cut the tension strap to length (pipe circumference + at least 120 mm).

Caution!



The edge of the tension strap is very sharp.

Risk of injury!

→ Debur sharp edges.

→ Wear the required personal protective equipment. Observe the applicable rules.

- Insert approx. 100 mm of the tension strap into one of the slots of the tension strap clamp and bend it, see Fig. 6.35.
- If necessary, insert the long end of the tension strap into the metal spring, see Fig. 6.36. The metal spring does not have to be mounted on:
 - steel pipes
 - pipes with an outer pipe diameter < 80 mm
 - pipes that are not subjected to significant temperature fluctuations
- Place the tension strap around the pipe, see Fig. 6.37.

Fig. 6.35: Tension strap with clamp

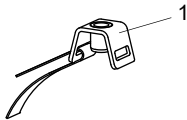

1 – tension strap clamp

Fig. 6.36: Tension strap with metal spring and clamp

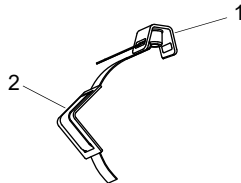

1 – tension strap clamp
2 – metal spring

- Position the tension strap clamp and metal spring (if necessary) on the pipe, see Fig. 6.37:
 - on a horizontal pipe, mount the tension strap clamp on the side of the pipe, if possible
 - mount the metal spring (if necessary) opposite to the tension strap clamp

Fig. 6.37: Tension strap with tension strap clamp and metal spring on the pipe

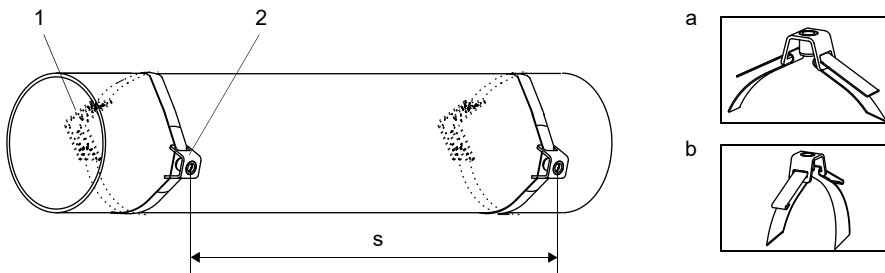

1 – metal spring
2 – tension strap clamp
s = length of the rail - 33 mm

- Insert the long end of the tension strap into the second slot of the tension strap clamp, see Fig. 6.37 a.
- Tighten the tension strap and bend it.
- Bend both ends of the tension strap, see Fig. 6.37 b.
- Repeat the steps for the second tension strap. Position the tension strap at the distance s, see Fig. 6.37.
- Put the rail on the tension strap clamps.
- Use the screws to fix the rail to the tension strap clamps, see Fig. 6.38.
- Tighten the screws.

Fig. 6.38: Rail on the pipe

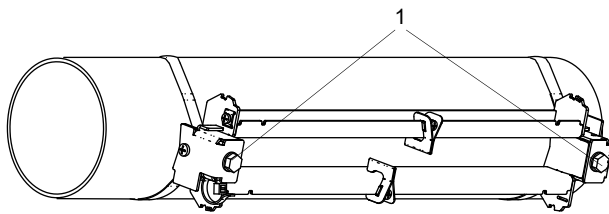

1 – screws

Mounting the rail with ratchet clasp

- Cut the tension strap to length (pipe circumference + at least 120 mm).

Caution!



The edge of the tension strap is very sharp.

Risk of injury!

- Debur sharp edges.
- Wear the required personal protective equipment. Observe the applicable rules.

- Insert approx. 100 mm of the tension strap into part (1) and (2) of the ratchet clasp, see Fig. 6.39 a.

Fig. 6.39: Ratchet clasp with tension strap

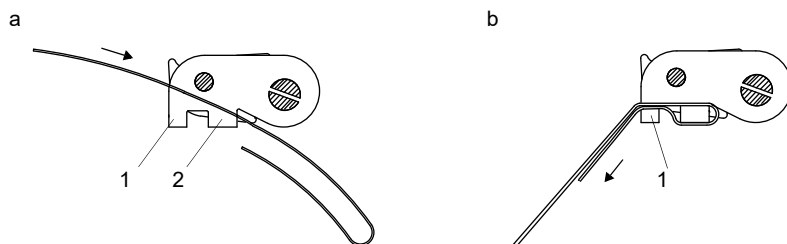

- Bend the tension strap.
- Insert the tension strap into part (1) of the ratchet clasp, see Fig. 6.39 b.
- Tighten the tension strap.
- Insert the long end of the tension strap into the tension strap clamp and the metal spring, see Fig. 6.40. The metal spring does not have to be mounted on:
 - steel pipes
 - pipes with an outer pipe diameter < 80 mm
 - pipes that are not subjected to significant temperature fluctuations
- Place the tension strap around the pipe, see Fig. 6.41.

Fig. 6.40: Tension strap with metal spring and clamp



1 – metal spring
2 – tension strap clamp

- Position the ratchet clasp, tension strap clamp and metal spring (if necessary) on the pipe:
 - on a horizontal pipe, mount the tension strap clamp on the side of the pipe, if possible
 - mount the metal spring (if necessary) opposite to the tension strap clamp
- Insert the long end of the tension strap into the second slot of the tension strap screw, see Fig. 6.42.
- Tighten the tension strap.
- Cut off the protruding tension strap, see Fig. 6.42.
- Tighten the screw of the ratchet clasp.
- Repeat the steps for the second tension strap.

Notice!
In order to release the screw and the tension strap, press the lever down, see Fig. 6.42.

Fig. 6.41: Ratchet clasp with tension strap, tension strap clamp and metal spring on the pipe

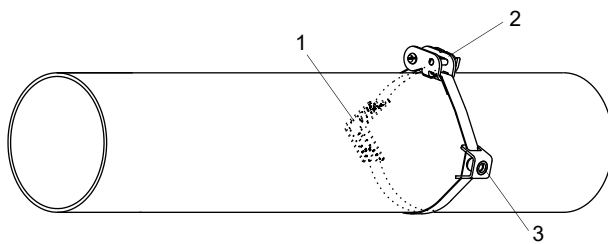

- 1 – metal spring
- 2 – ratchet clasp
- 3 – tension strap clamp

Fig. 6.42: Ratchet clasp with tension strap

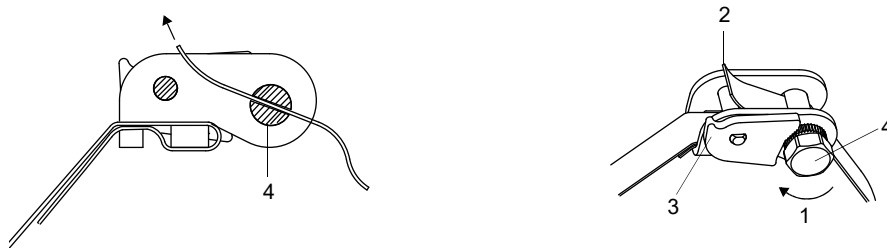

- 1 – sense of rotation
- 2 – edge
- 3 – lever
- 4 – clasp screw with slot

- Put the rail on the tension strap clamps, see Fig. 6.43.
- Fix the rail to the tension strap clamps with the screws.
- Tighten the screws.

Fig. 6.43: Rail on the pipe

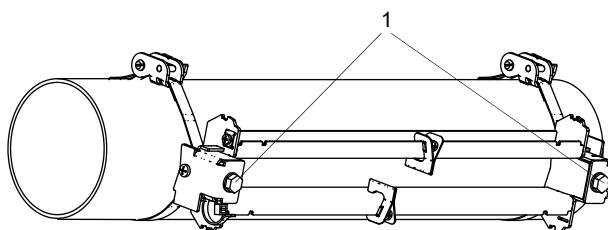

- 1 – screws

Step 3: Installation of the transducers in the transducer mounting fixture Variofix C

- Stick coupling foil (or some coupling compound for a short-term installation) on the contact surface of the transducers. The coupling foil can be fixed to the contact surface with a small amount of coupling compound.

Notice!

If the signal is not sufficient for the measurement, use coupling compound instead of coupling foil. For information concerning the coupling foil or coupling compound, see the safety data sheet. In case a safety data sheet is required, contact FLEXIM.

- Position the transducers on the rail in such way that the engravings on the transducers form an arrow. The transducer cables show in opposite directions, see Fig. 6.44.
- Adjust the transducer distance displayed by the transmitter, see Fig. 6.44.
- Slide the spring clips on the transducers, see Fig. 6.45.
- Fix the transducers by tightening the tensioning screws slightly. The end of the tensioning screw has to be placed above the hole in the transducer, see Fig. 6.44 and Fig. 6.45.
- Correct the transducer distance, if necessary.
- Tighten the tensioning screws.
- Fix the spacing element on the rail to mark the transducer position, see Fig. 6.44.
- Use a cable tie to fix the transducer cables in order to protect them from mechanical strain, see Fig. 6.45.
- Put the cover on the rail, see Fig. 6.46.
- Tighten the screws on both sides of the cover.

Fig. 6.44: Transducers in the rail (spring clip not shown)

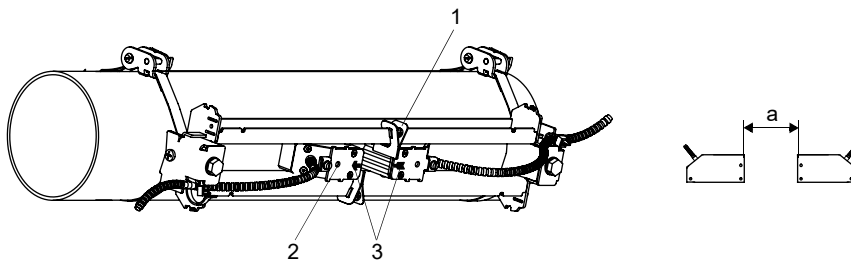

- 1 – spacing element
- 2 – hole
- 3 – engravings on the transducers
- a – transducer distance

Fig. 6.45: Transducers in the rail

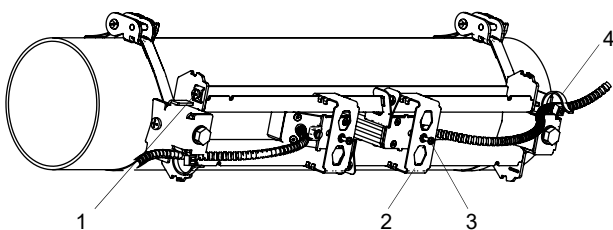

- 1 – equipotential bonding terminal
- 2 – spring clip
- 3 – tensioning screw
- 4 – cable tie

Fig. 6.46: Variofix C with transducers on the pipe

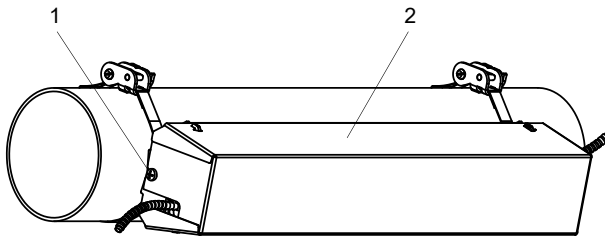

- 1 – screw
- 2 – cover

Remove the cover from the mounted transducer mounting fixture Variofix C as follows:

- Use a lever tool to remove the cover.
- Insert the lever tool in one of the 4 openings of the cover, see Fig. 6.47.
- Press the lever tool against the fixture.
- Bend the cover outwards and release it from the anchoring.
- Repeat the steps for the other 3 openings.
- Remove the cover from the rail.

Fig. 6.47: Removal of the cover

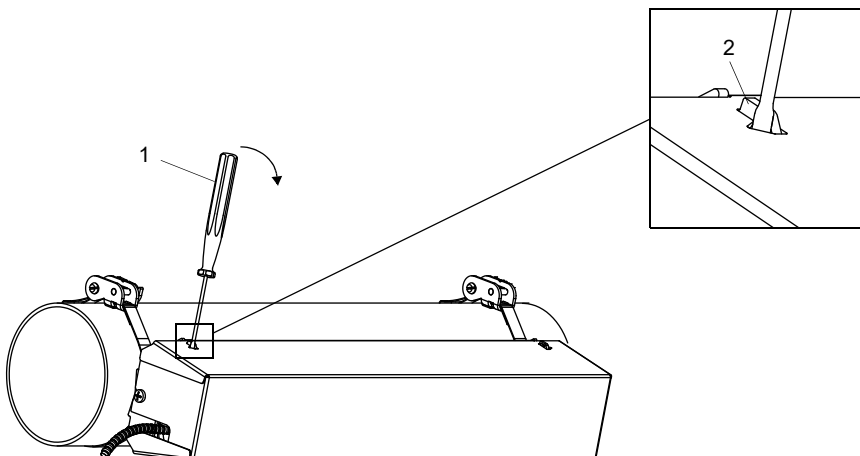

- 1 – lever tool
- 2 – fixture

6.2.2.5 Installation with mounting shoe and tension strap

- Cut the tension straps to length (pipe circumference + at least 120 mm).
- Make sure that part (2) of the clasp is on top of part (1), see Fig. 6.48. The hooks of part (2) have to be on the outer side of the clasp.
- Pull approx. 20 mm of the tension strap through the slot of the clasp to fix the clasp to the tension strap, see Fig. 6.49.
- Bend the end of the tension strap and insert the other end of the tension strap into the groove on the upper side of the transducer shoe.
- Place the clasp on the side of the pipe showing towards you and put the tension strap around the pipe, see Fig. 6.50.
- Place the transducer shoe on the pipe. Hold the clasp and the transducer shoe with one hand and insert the tension strap through parts (2) and (1) of the clasp, see Fig. 6.48.
- Tighten the tension strap and engage it in the inner hook of the clasp.
- Tighten the screw of the clasp.

Fig. 6.48: Clasp

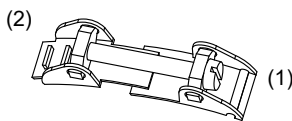
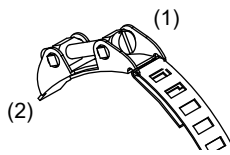

Fig. 6.49: Clasp with tension strap



Notice!

On pipes with large diameters, use tongs to tighten the tension strap, if necessary.

Notice!

The clasp has to be completely in contact with the pipe to ensure a good fixation.

- Fix the second transducer shoe in the same way. Adjust the displayed transducer distance by means of the measuring tape.
- Insert the transducers into the transducer shoes.
- Press the transducers firmly on the pipe. There should be neither a gap nor air pockets between the transducer surface and the pipe wall. Tighten the transducer shoe screws.

Notice!

If the transducers are mounted on a vertical pipe and the transmitter is placed lower than the transducers, the transducer cables should be fixed to the tension strap by a cable tie to protect them from mechanical strain.

Fig. 6.50: Installation of the transducers with transducer shoes

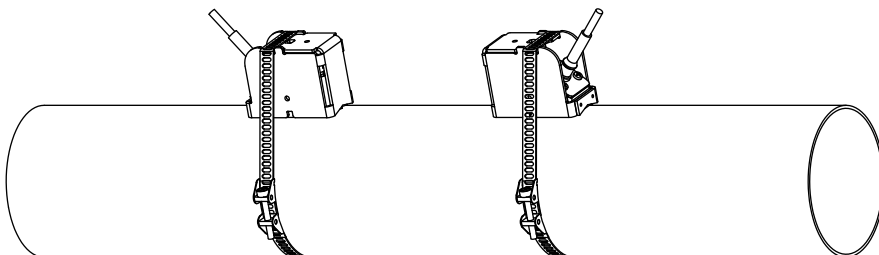

6.2.2.6 Mounting with tension strap and quick release clasp

Caution!



The edge of the tension strap is very sharp.

Risk of injury!

→ Debur sharp edges.

→ Wear the required personal protective equipment. Observe the applicable rules.

The clasp is fixed to the tension strap, see Fig. 6.51.

Fig. 6.51: Tension strap with quick release clasp

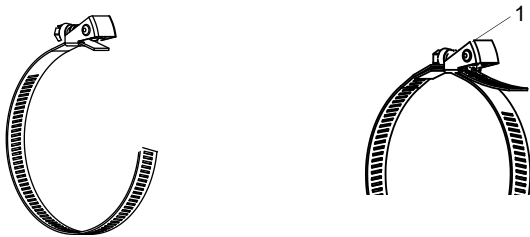

1 – clasp screw

- Cut the tension strap to length (pipe circumference + 120 mm).
- Position the sensor on the pipe, see Fig. 6.52.
- Place the tension strap around transducer and the pipe.
- Place the tension strap around the pipe and insert it into the clasp.
- The clasp has to be on the pipe.
- Tighten the tension strap.
- Tighten the clasp screw.

Fig. 6.52: Transducer on the pipe

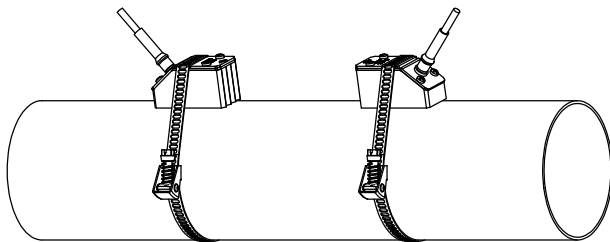

7 Connection

Warning!



Installation, connection and start-up by unauthorized and unqualified personnel

This may result in personal or material damage or other dangerous situations.

→ Any work on the transmitter has to be carried out by authorized and qualified personnel.

Warning!



Touching live parts

Electric shock or arc faults can lead to severe injuries. The measuring equipment can be damaged.

→ Prior to any work on the transmitter (e.g., installation, dismantling, connection, start-up), the transmitter has to be disconnected from the power supply. It is not sufficient to remove the internal fuse of the instrument, see section 7.2.

Caution!



Safety and accident prevention regulations for electrical systems and equipment

Failure to observe these regulations may lead to death or severe injury.

→ Observe the safety and accident prevention regulations for electrical systems and equipment.

7.1 Transducers

It is recommended to run the cables from the measuring point to the transmitter before connecting the transducers to avoid load on the connectors.

Notice!

If transducers are replaced, the sensor module also has to be replaced, see section 7.1.5.

Fig. 7.1: Connection of the transducers to the transmitter

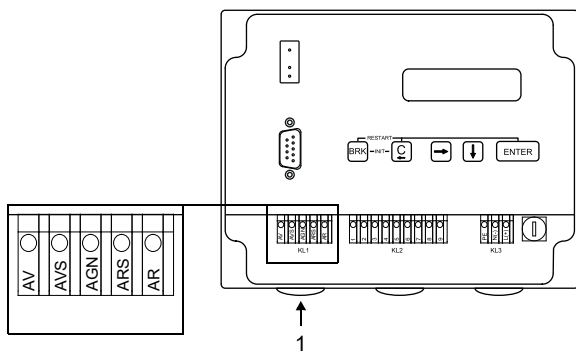

1 – transducer connection

7.1.1 Connection of the transducer cable to the transmitter

Important!

The degree of protection of the transmitter is only ensured if all cables are tightly fitted using cable glands and the housing is firmly screwed.

- Remove the protection hose (at the end of the transducer cable) by cutting it (see Fig. 7.2). Make sure not to damage the transducer cable.

Fig. 7.2: Transducer cable with protection hose

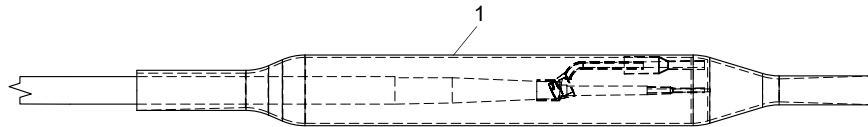

1 – protection hose

- Remove the blind plug for the connection of the transducer cable.
- Open the cable gland of the transducer cable. The compression part remains in the cap nut.
- Push the transducer cable through the cap nut and the compression part.
- Prepare the transducer cable.
- Shorten the external shield and brush it back over the compression part.
- Screw the sealing ring side of the basic part into the transmitter housing.
- Insert the transducer cable into the housing.

Notice!

For good electromagnetic compatibility (EMC), it is important to ensure good electrical contact between the external shield and the cap nut (and thus the housing).

- Fix the cable gland by screwing the cap nut onto the basic part.
- Connect the transducer cable to the terminals of the transmitter, see Fig. 7.3 and Tab. 7.1.

Tab. 7.1: Terminal assignment





| terminal | connection |
|----------|--|
| AV | transducer  (core) |
| AVS | transducer  (internal shield) |
| ARS | transducer  (inner shield) |
| AR | transducer  (core) |

Fig. 7.3: Connection of the transducer cable with plastic cable jacket and stripped cable ends to the transmitter



- 1 – cap nut
- 2 – compression part
- 3 – basic part
- 4 – external shield brushed back

7.1.2 Connection of the extension cable to the transmitter

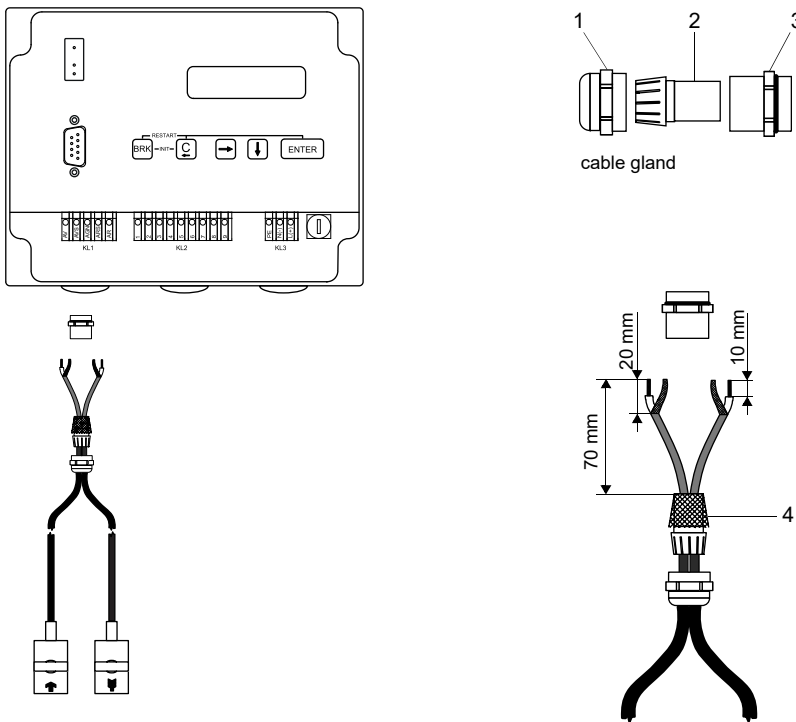
The extension cable is connected to the transmitter via the transducer connection.

- Remove the blind plug for the connection of the transducer cable.
- Open the cable gland of the extension cable. The compression part remains in the cap nut.
- Push the extension cable through the cap nut and the compression part.
- Prepare the extension cable.
- Shorten the external shield and brush it back over the compression part.
- Screw the sealing ring side of the basic part into the transmitter housing.
- Insert the extension cable into the housing.

Notice!

For good electromagnetic compatibility (EMC), it is important to ensure good electrical contact between the external shield and the cap nut (and thus the housing).

- Fix the cable gland by screwing the cap nut onto the basic part.
- Connect the extension cable to the terminals of the transmitter, see Fig. 7.4 and Tab. 7.2.

Tab. 7.2: Terminal assignment

| terminal | connection |
|----------|---|
| AV | white or marked cable (core) |
| AVS | white or marked cable (internal shield) |
| ARS | brown cable (internal shield) |
| AR | brown cable (core) |

Fig. 7.4: Connection of the extension cable to the transmitter

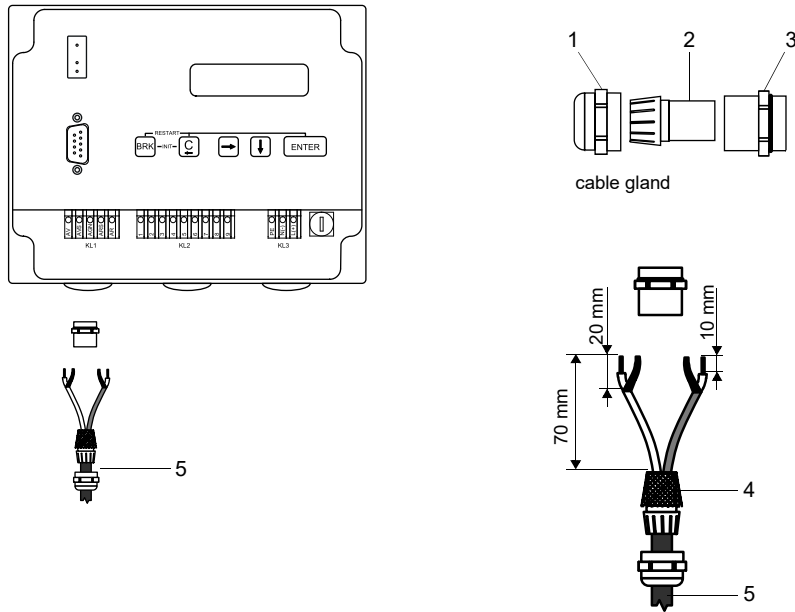

- 1 – cap nut
- 2 – compression part
- 3 – basic part
- 4 – external shield brushed back
- 5 – extension cable

7.1.3 Connection of the transducer cable to the junction box

- Remove the blind plug for the connection of the transducer cable, see Fig. 7.5.
- Open the cable gland of the transducer cable. The compression part remains in the cap nut.
- Push the transducer cable through the cap nut and the compression part.
- Prepare the transducer cable.
- Shorten the external shield and brush it back over the compression part.
- Screw the gasket ring side of the basic part into the junction box.
- Insert the transducer cables into the junction box.

Notice!

For good electromagnetic compatibility (EMC), it is important to ensure good electrical contact between the external shield and the cap nut (and thus the housing).

- Fix the cable gland by screwing the cap nut onto the basic part.
- Connect the transducer cable to the terminals of the junction box, see Fig. 7.5 and Tab. 7.3.

Tab. 7.3: Terminal assignment

| terminal | connection |
|----------|-------------------------------|
| V | transducer (core) |
| VS | transducer (internal shield) |
| RS | transducer (inner shield) |
| R | transducer (core) |

Fig. 7.5: Connection of the transducer cable with plastic cable jacket and stripped cable ends

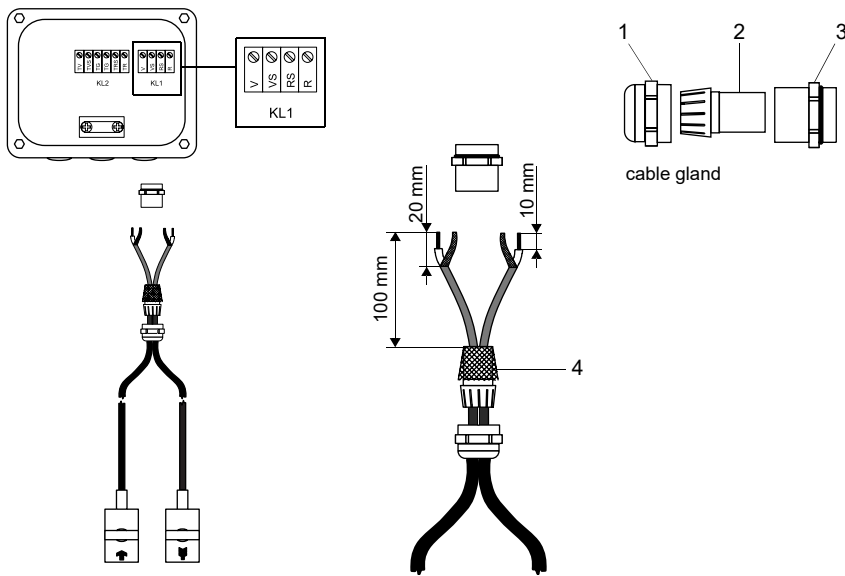

- 1 – cap nut
- 2 – compression part
- 3 – basic part
- 4 – external shield brushed back

7.1.4 Connection of the extension cable to the junction box

7.1.4.1 Connection without potential separation (standard)

The connection of the extension cable to the junction box without potential separation ensures that transducer, junction box and transmitter are on the same potential. The extension cable should always be connected in this manner, especially if power current cables are nearby the extension cable. If earthing on the same potential cannot be ensured, see section 7.1.4.1.

- Remove the blind plug for the connection of the extension cable.
- Open the cable gland of the extension cable. The compression part remains in the cap nut.
- Push the extension cable through the cap nut and the compression part.
- Prepare the extension cable.
- Shorten the external shield and brush it back over the compression part.
- Screw the gasket ring side of the basic part into the junction box.
- Insert the extension cable into the junction box.

Notice!

For good electromagnetic compatibility (EMC), it is important to ensure good electrical contact between the external shield and the cap nut (and thus the housing).

- Fix the cable gland by screwing the cap nut onto the basic part.
- Connect the extension cable to the terminals of the junction box, see Fig. 7.6 and Tab. 7.4.

Tab. 7.4: Terminal assignment

| terminal | connection (extension cable) |
|-------------|---|
| TV | white or marked cable (core) |
| TVS | white or marked cable (internal shield) |
| TRS | brown cable (internal shield) |
| TR | brown cable (core) |
| cable gland | external shield |

Fig. 7.6: Connection of the extension and transducer cable to the junction box

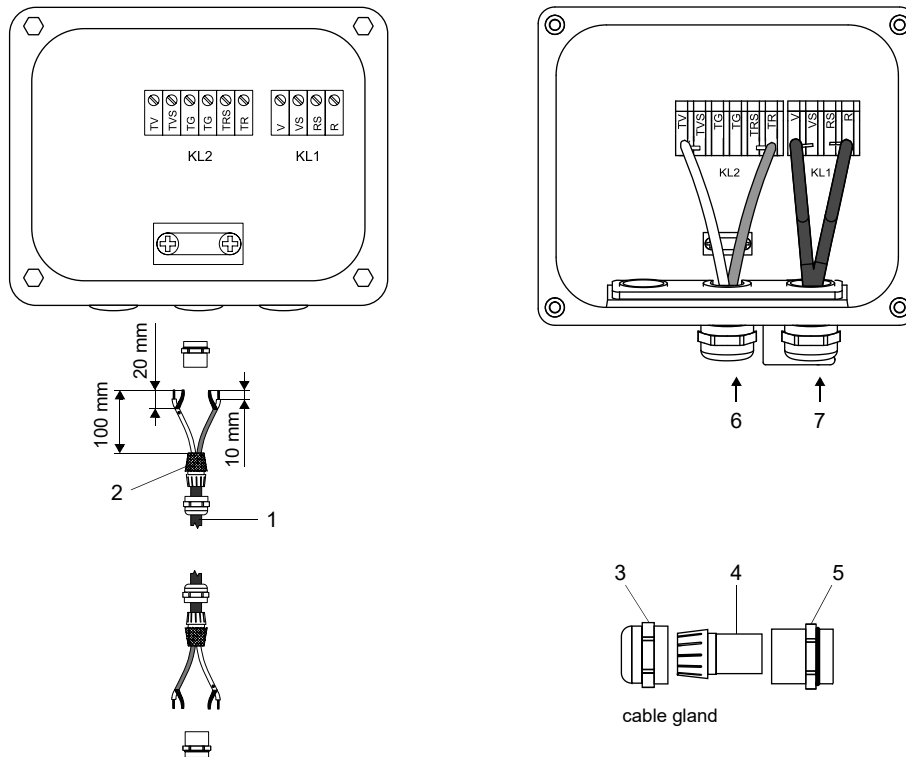

- 1 – extension cable
- 2 – external shield brushed back
- 3 – cap nut
- 4 – compression part
- 5 – basic part
- 6 – connection of the extension cable
- 7 – connection of the transducer cable

7.1.4.2 Connection with potential separation

If earthing on the same potential cannot be ensured e.g., in measurement arrangements with long extension cables, the extension cable and the junction box have to be electrically insulated from each other. The junction box and the transducers have to be on the same potential. By doing this, no compensation currents can flow to the transmitter via the extension cables. For measurement arrangements where the junction box and the transducers have to be electrically insulated from each other, see the document TIFLUXUS_GalvSep.

- Remove the blind plug for the connection of the extension cable.
- Open the cable gland of the extension cable. The compression part remains in the cap nut.
- Push the extension cable through the cap nut, the compression part and the basic part.
- Insert the extension cable into the junction box.
- Prepare the extension cable.
- Cut the outer shield and brush it back.
- Pull the extension cable back until the back brushed external shield is below the shield terminal, see Fig. 7.7. The extension cable has to remain completely insulated up to the shield terminal.
- Screw the gasket ring side of the basic part into the junction box.
- Fix the cable gland by screwing the cap nut onto the basic part.

Important!

Observe the max. permissible voltage of 60 V DC between the earth potentials.

Important!

The external shield of the extension cable must not have electrical contact to the junction box. Therefore, the extension cable has to remain completely insulated up to the shield terminal.

- Fix the extension cable and the external shield to the shield terminal.
- Connect the extension cable to the terminals of the junction box, see Fig. 7.7 and Tab. 7.5.

Tab. 7.5: Terminal assignment

| terminal | connection (extension cable) |
|-----------------|---|
| TV | white or marked cable (core) |
| TVS | white or marked cable (internal shield) |
| TRS | brown cable (internal shield) |
| TR | brown cable (core) |
| shield terminal | external shield |

Fig. 7.7: Connection of the extension and transducer cable to the junction box

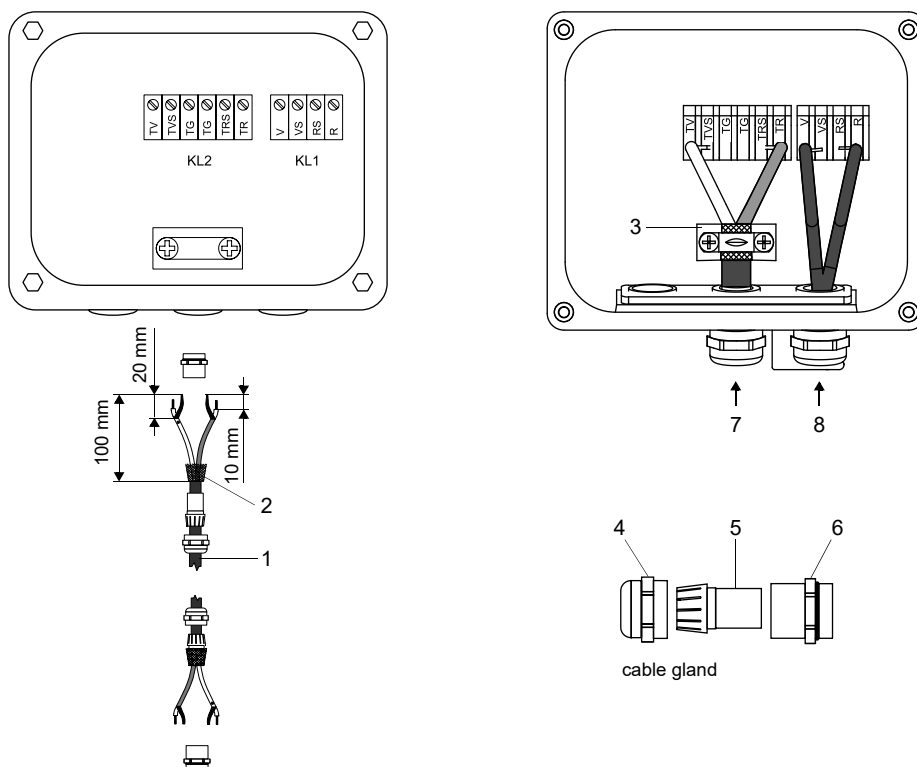

- 1 – extension cable
- 2 – external shield
- 3 – shield terminal
- 4 – cap nut
- 5 – compression part
- 6 – basic part
- 7 – connection of the extension cable
- 8 – connection of the transducer cable

7.1.5 Transducer module (SENSPROM)

The transducer module contains important transducer data for the operation of the transmitter with transducers. If transducers are replaced, the sensor module must also be replaced.

Notice!

The serial numbers of the transducer module and the transducer must be identical. A wrong or incorrectly connected sensor module will lead to incorrect measured values or to a measurement failure.

- Disconnect the transmitter from the power supply.
- Insert the transducer module into the socket, see Fig. 7.8.
- Connect the transmitter to the power supply.
- Enter all parameters of the program branch `Parameter`.
- Start the measurement.

Fig. 7.8: Connection of the transducer module

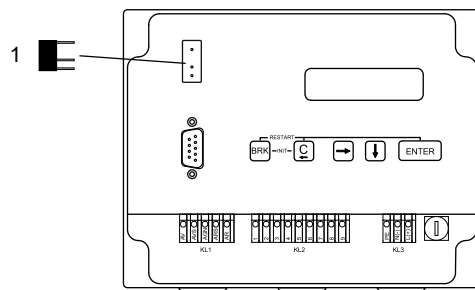

1 – transducer module

7.2 Power supply

Important!

The degree of protection of the transmitter will only be guaranteed if the power cable fits firmly and tightly in the cable gland.

- Connect the power cable to the transmitter.

For the connection of the power supply cable to the transmitter, see section 7.2.1, Fig. 7.9 and Tab. 7.6.

Fig. 7.9: Connection of the power supply to the transmitter

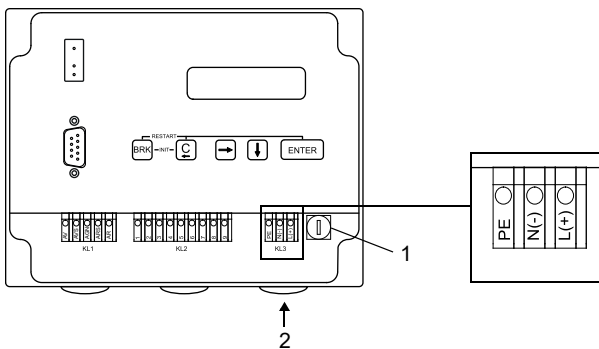

- 1 – fuse
- 2 – connection of the power supply

Tab. 7.6: Terminal assignment

| terminal | connection AC | connection DC |
|----------|---------------|---------------|
| PE | earth | earth |
| N(-) | neutral | - |
| L(+) | phase | + |

7.2.1 Cable connection

- Remove the blind plug to connect the cable to the transmitter.
- Prepare the cable with an M20 cable gland.
- The used cable has to have a wire cross-section of 0.25...2.5 mm².
- Push the cable through the cap nut, compression part and basic part of the cable gland.
- Insert the cable into the housing of the transmitter.
- Screw the sealing ring side of the basic part into the transmitter housing.
- Fix the cable gland by screwing the cap nut onto the basic part.
- Connect the cable to the terminals of the transmitter.

Fig. 7.10: Cable gland

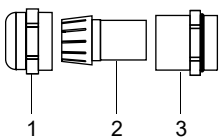

- 1 – cap nut
- 2 – compression part
- 3 – basic part

7.3 Outputs

Important!
The max. permissible voltage between the outputs and against PE is 60 V DC (permanent).

- Connect the output cable to the transmitter.

For the connection of the output cable to the transmitter, see section 7.2.1, Fig. 7.11 and Tab. 7.7.

Fig. 7.11: Connection of the outputs on the transmitter

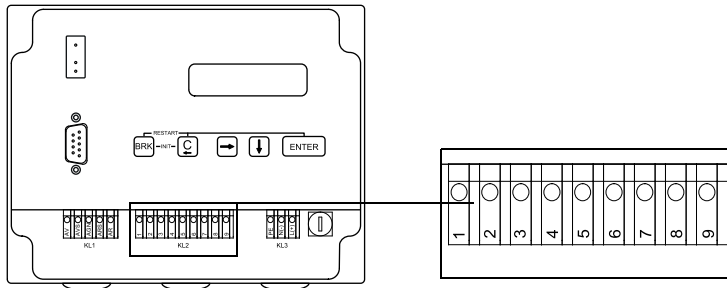

Tab. 7.7: Circuit of the outputs

| output | transmitter | | external circuit | remark |
|---------------------------|------------------|--------------------------|------------------|---|
| | internal circuit | connection | | |
| active current output | | I1: 6 I1: 5 | | $R_{ext} < 500 \Omega$ |
| binary output (optorelay) | circuit 1 | | | $U_{ext} \leq 28 \text{ V DC}$ $I_c \leq 100 \text{ mA}$ $R_c [\text{k}\Omega] = U_{ext} / I_c [\text{mA}]$ |
| | | B1/B2: 2/4 B1/B2: 1/3 | | |
| | circuit 2 | | | |
| | | B1/B2: 2/4 B1/B2: 1/3 | | |

The number, type and the connections of the outputs depend on the order.

R_{ext} is the sum of all ohmic resistances in the circuit (e.g., resistance of the conductors, resistance of the ammeter/voltmeter).

Tab. 7.7: Circuit of the outputs

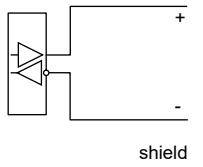
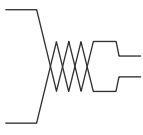
| output | transmitter | | external circuit | remark |
|-------------------|---|----------------------------------|---|-------------------------------|
| | internal circuit | connection | | |
| RS485 (option) |  | 8 (A+) 7 (B-) 9 shield |  | 120 Ω termination resistor |

The number, type and the connections of the outputs depend on the order.

R_{ext} is the sum of all ohmic resistances in the circuit (e.g., resistance of the conductors, resistance of the ammeter/voltmeter).

7.4 Serial interfaces

7.4.1 RS232 service interface

The RS232 service interface is located on the front plate of the transmitter, see Fig. 7.12.

- Connect the RS232 cable to the transmitter and the serial interface of the PC. If the RS232 cable cannot be connected to the PC, use the RS232/USB adapter.

The RS232/USB adapter and the RS232 cable are part of the serial data kit (optional).

Notice!

If a problem occurs when using the RS232/USB adapter for connection, contact your system administrator.

Fig. 7.12: Transmitter

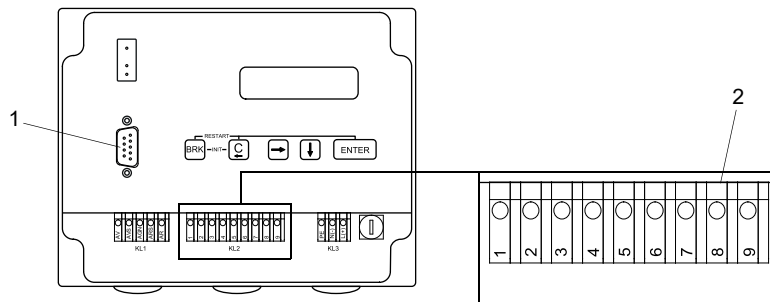

- 1 – RS232 service interface
- 2 – connection of the RS485 process interface (option)

7.4.2 RS485 process interface

The transmitter can also be equipped with an RS485 interface (optional).

For the connection of the RS485 cable to the transmitter, see section 7.2.1, Fig. 7.12 and Tab. 7.7.

8 Start-up

Warning!



Installation, connection and start-up by unauthorized and unqualified personnel

This may result in personal or material damage or other dangerous situations.

→ Any work on the transmitter has to be carried out by authorized and qualified personnel.

Caution!



Safety and accident prevention regulations for electrical systems and equipment

Failure to observe these regulations may lead to death or severe injury.

→ Observe the safety and accident prevention regulations for electrical systems and equipment.

Notice!

The transmitter and transducers have to be checked to ensure proper condition and operational safety before each use. The transmitter housing must always be closed during operation. Observe that maintenance work must be concluded.

8.1 Start-up settings

When starting up the transmitter for the first time, the following settings are required:

- language
- units of measurement
- date/time

These displays will only be indicated once when the transmitter is switched on for the first time.

Select language

The available transmitter languages are displayed.

- Select a language.
- Press ENTER.

The menus are displayed in the selected language.

Engineer. Units

- Select `metric` or `imperial`.
- Press ENTER.



CANADA-REGION

- Select `yes` if the transmitter is to be used in the region of Canada.
- Press ENTER.

This display will only be indicated if `imperial` is selected.



TIME

The current time is displayed.

- Press ENTER to confirm the time or to set the current time via the keys  and .
- Press ENTER.

DATE

The current date is displayed.

- Press ENTER to confirm the date or to set the current date via the keys  and .
- Press ENTER.

8.2 Switching on

As soon as the transmitter is connected to the power supply, the serial number of the transmitter is displayed for a short time. It is not possible to enter any data while the serial number is displayed.

Afterwards, the main menu is displayed in the default language. The language can be changed (see section 8.5).

8.3 Program branches

The following schema shows the program branches. For a detailed overview of the menu structure see annex A.

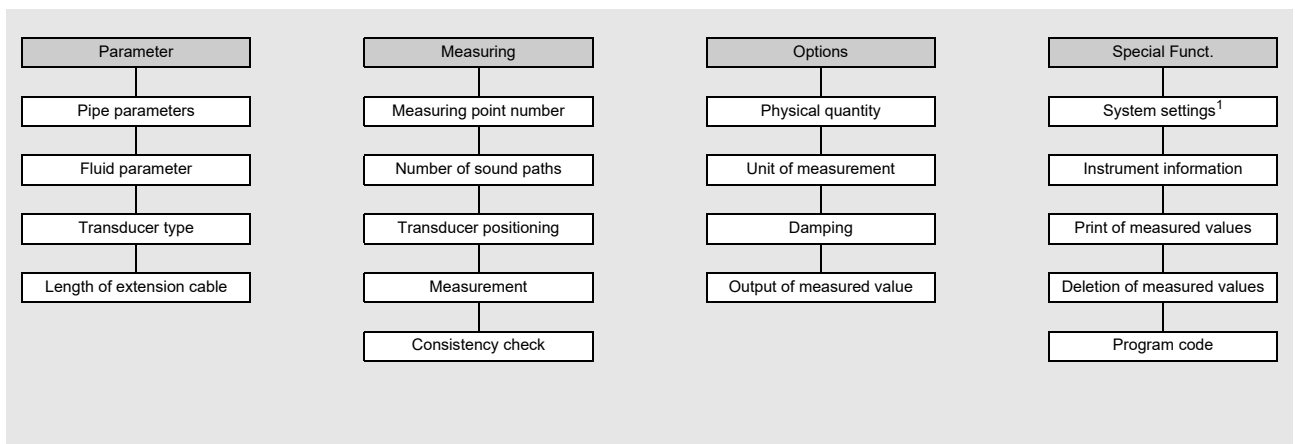

¹ SYSTEM settings contains the following menu items:

- dialogs and menus
- measurement
- outputs
- storing
- snap
- network
- serial transmission
- miscellaneous
- clock settings
- libraries

8.4 HotCodes

A HotCode is a digit sequence that activates certain functions and settings.

```
Special Funct.\SYSTEM settings\Miscellaneous
```

- Select the menu item `Miscellaneous` in the program branch `Special Funct.\SYSTEM settings`.
- Press ENTER.

```
Input a HOTCODE
```

- Select `yes` to enter a HotCode.
- Press ENTER.

```
Please input a HOTCODE: 000000
```

- Enter the HotCode.
- Press ENTER.
- The error message `INVALID HOTCODE` will be displayed if an invalid HotCode has been entered.
- Press ENTER.

```
Input a HOTCODE
```

- Select `yes` to enter the HotCode again or `no` to return to the menu item `Miscellaneous`.
- Press ENTER.

| function | HotCode |
|---|---------|
| reset of the display to medium contrast | 555000 |
| language | 9090xx |
| manual input of the lower limit for the inner pipe diameter | 071001 |
| activation/deactivation of the SuperUser mode | 071049 |
| transmission parameters change of the RS232 service interface | 232-0- |

8.5 Language

The language can be selected with the following HotCodes:

| language | HotCode |
|----------|---------|
| Dutch | 909031 |
| French | 909033 |
| Spanish | 909034 |
| English | 909044 |
| German | 909049 |

When the last digit has been entered, the main menu is displayed in the selected language.

The selected language remains activated when the transmitter is switched off and on again. After an initialization of the transmitter, the language is reset to the default language.

8.6 Initialization

During an initialization (INIT) of the transmitter, the settings in the program branches `Parameter` and `Output Options` and some of the settings in the program branch `Special Funct.` are reset to the default settings of the manufacturer.

Proceed as follows to execute an initialization:

- When switching on the transmitter: keep keys BRK and C pressed.
- During the operation of the transmitter: press keys BRK, C and ENTER at the same time. A reset is executed. Release only key ENTER. Keep keys BRK and C pressed.

After the initialization has been executed, the message `INITIALISATION DONE` is displayed.

After the initialization, the remaining settings of the transmitter can be reset to the default settings and/or the stored measured values can be deleted.

```
FACTORY DEFAULT
```

- Select `yes` to reset the remaining settings of the transmitter to default settings or `no` to keep them at the current settings.
- Press ENTER.

If `yes` is selected, the message `FACTORY DEFAULT DONE` will be displayed.

```
Delete Meas.Val.
```



- Select `yes` to delete the stored measured values or `no` to keep them.
- Press ENTER.

This display will only be indicated if measured values are stored in the transmitter.

8.7 Time and date

The transmitter has a battery-powered clock. Measured values are automatically stored with date and time.

```
Special Funct.\SYSTEM settings\Set Clock\TIME
```



- Select the menu item `Set Clock`.
 - Press ENTER.
- The current time is displayed.
- Select `ok` to confirm the time or `new` to adjust it.
 - Press ENTER.
 - Select the character to be edited with key . Edit the selected character with key .
 - Press ENTER.

The new time is displayed.

- Select `ok` to confirm the time or `new` to adjust it again.
- Press ENTER.

```
Special Funct.\SYSTEM settings\Set Clock\DATE
```

After the time has been set, the date is displayed.

- Select `ok` to confirm the date or `new` to adjust it.
- Press ENTER.
- Select the character to be edited with key . Edit the selected character with key .
- Press ENTER.

The new date is displayed.

- Select `ok` to confirm the date or `new` to adjust it again.
- Press ENTER.

8.8 Instrument information

```
Special Funct.\Instrum. Inform.
```

- Select the menu item `Instrum. Inform.` to get information about the transmitter.
- Press ENTER.

```
F501      -XXXXXXXX
```

The type and the serial number of the transmitter are displayed in the upper line.

```
Free:      18327
```

The max. available data logger will be displayed in the lower line (here: 18 327 additional measured values can be stored).

- Press ENTER.

```
V x.xx    dd.mm.yy
```

The firmware version of the transmitter is displayed with the date in the lower line.

- Press ENTER.

8.9 Interruption of the power supply

As soon as the measurement begins, all current measuring parameters will be stored in a non-volatile INIT-resistant EPROM. In case of a power supply failure, the measurement will be stopped. All entered data remain stored.

```
F501      -XXXXXXXX
```

After the power supply has returned, the serial number is displayed in the lower line for a few seconds.

The interrupted measurement is continued. All selected output options are still activated. The measurement will not be continued after the return of the power supply if an initialization has been performed.

9 Measurement

Warning!



Installation, connection and start-up by unauthorized and unqualified personnel

This may result in personal or material damage or other dangerous situations.

→ Any work on the transmitter has to be carried out by authorized and qualified personnel.

Caution!



Safety and accident prevention regulations for electrical systems and equipment

Failure to observe these regulations may lead to death or severe injury.

→ Observe the safety and accident prevention regulations for electrical systems and equipment.

9.1 Parameter input

Notice!

The parameters will only be stored when the program branch `Parameter` has been edited in its entirety.

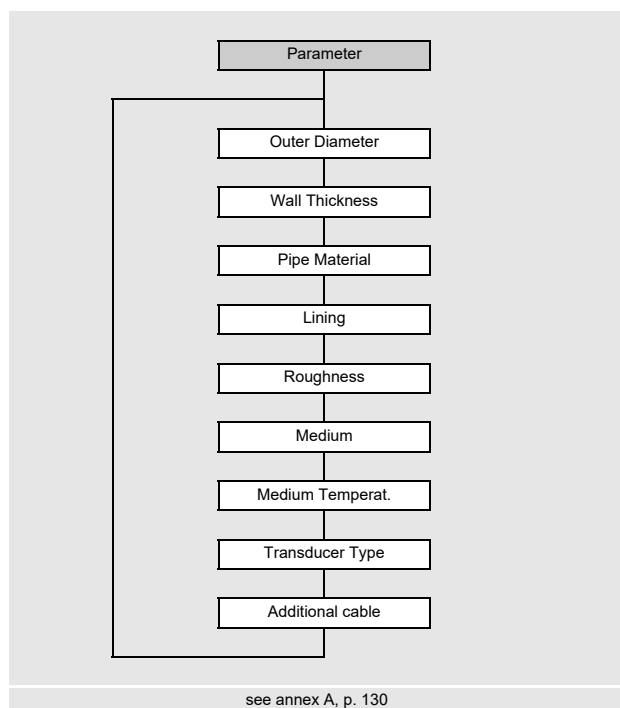

The pipe and fluid parameters are entered for the selected measuring point. The parameter ranges are limited by the technical characteristics of the transducers and the transmitter.

- Select the program branch `Parameter`.
- Press ENTER.

9.1.1 Input of pipe parameters

Outer pipe diameter/pipe circumference

`Parameter\Outer Diameter`

- Enter the outer pipe diameter.
- Press ENTER.

An error message will be displayed if the entered parameter is outside the range. The limit is displayed.

Example: upper limit 1100 mm for the connected transducers and for a pipe wall thickness of 50 mm.

| |
|----------------------------------|
| Outer Diameter 1100.0 MAXIMAL |
|----------------------------------|

It is possible to enter the pipe circumference instead of the outer pipe diameter, see section 18.1.

If the input of the pipe circumference is activated and zero is entered in `Outer Diameter`, the menu item `Pipe Circumfer.` will be displayed. If the pipe circumference is not to be entered, press key BRK to return to the main menu and start the parameter input again.

Notice!

The inner pipe diameter (= outer pipe diameter - 2 × pipe wall thickness) will be calculated internally.
If the value is not within the inner pipe diameter range of the connected transducers, an error message will be displayed.
It is possible to change the lower limit of the inner pipe diameter for a given transducer type, see section 16.8.

Pipe wall thickness

Parameter\Wall Thickness

- Enter the pipe wall thickness.
- Press ENTER.

Pipe material

Parameter\Pipe Material

The pipe material has to be selected to be able to determine the corresponding sound speed.
The sound speeds for the materials in the scroll list are stored in the transmitter.

- Select the pipe material.
- Press ENTER.
- If the material is not in the scroll list, select `Other Material`.
- Press ENTER.

Sound speed of the pipe material

Parameter\Pipe Material\Other Material\c-Material

- Enter the sound speed of the pipe material.
- Press ENTER.

Notice!

There are 2 sound speeds for pipe materials, the longitudinal and the transversal one. Enter the sound speed which is nearer to 2500 m/s.

These displays will only be indicated if `Other Material` is selected.
For the sound speed of some materials, see annex C.

Lining

Parameter\Lining

- Select `yes` if the pipe has a lining.
- Select `no` if the pipe has no lining.
- Press ENTER.

Lining material

Parameter\Lining

- Select the lining material.
- Press ENTER.
- If the lining material is not included in the scroll list, select `Other Material`.
- Press ENTER.

This display will only be indicated if `yes` is selected in the menu item `Lining`.

Sound speed of the lining material

Parameter\Lining\Other Material\c-Material

- Enter the sound speed of the lining material.
- Press ENTER.

Notice!

For pipe materials there are 2 sound speeds, the longitudinal and the transversal one. Enter the sound speed which is nearer to 2500 m/s.

These displays will only be indicated if `Other Material` is selected.

Lining thickness

Parameter\Liner Thickness

- Enter the thickness of the lining.
- Press ENTER.

This display will only be indicated if `yes` is selected in the menu item `Lining`.

Pipe roughness

Parameter\Roughness

The flow profile of the fluid is influenced by the roughness of the inner pipe wall.

The roughness is used for the calculation of the profile correction factor.

In most cases, the pipe roughness cannot be exactly determined and must therefore be estimated.

For the roughness of some materials, see annex C.

- Enter the roughness for the selected pipe or lining material.
- Change the value according to the condition of the inner pipe wall.
- Press ENTER.

Input of the disturbance distance

Parameter\Disturb.distance

- Enter the disturbance distance.
- Press ENTER.

This display will only be indicated if `With disturbance` is selected in the menu item `Special Funct.\SYSTEM settings\Measuring\ProfileCorr 2.0`.

9.1.2 Input of fluid parameters

Fluid

```
Parameter\Medium
```

- Select the fluid from the scroll list.
- Press ENTER.

If the fluid is not in the scroll list, select `Other Medium`.

If a fluid is selected from the scroll list, the menu item for the input of the fluid temperature will directly be displayed.

If `Other Medium` is selected, the following fluid parameters have to be entered first:

- average sound speed of the fluid
- range around the average sound speed of the fluid
- kinematic viscosity
- density

Sound speed of the fluid

```
Parameter\Medium\Other Medium\c-Medium
```

The sound speed of the fluid is used for the calculation of the transducer distance. The exact value of the sound speed is not always known. Therefore, a range of possible values for the sound speed has to be entered.

- Enter the average sound speed of the fluid.
- Press ENTER.

This display will only be indicated if `Other Medium` is selected.

Sound speed range of the fluid

```
Parameter\Medium\Other Medium\c-Medium range
```

- Select `auto` if the area around the average sound speed is to be calculated by the transmitter.
- Select `user` if the range around the average sound speed has to be entered.
- Press ENTER.

This display will only be indicated if `Other Medium` is selected.

```
Parameter\Medium\Other Medium\c-Medium range\c-Medium
```

- Enter the range around the average sound speed of the fluid.
- Press ENTER.

This display will only be indicated if `user` is selected.

Kinematic viscosity of the fluid

```
Parameter\Medium\Other Medium\Kinem.Viscosity
```

The kinematic viscosity influences the flow profile of the fluid. The value is considered in the profile correction.

- Enter the kinematic viscosity of the fluid.
- Press ENTER.

This display will only be indicated if `Other Medium` is selected.

Fluid density

```
Parameter\Medium\Other Medium\Density
```

The density is used to calculate the mass flow.

If the mass flow is not measured, an input is unnecessary. The default value can be used.

- Enter the operating density of the fluid.
- Press ENTER.

This display will only be indicated if `Other Medium` is selected.

Fluid temperature

```
Parameter\Medium Temperat.
```

At the beginning of the measurement, the fluid temperature is used for the interpolation of the sound speed and therefore for the calculation of the recommended transducer distance.

During the measurement, the fluid temperature is used for the interpolation of the density and viscosity of the fluid.

The value entered here is used for the calculation if the fluid temperature is not measured.

- Enter the fluid temperature. The value has to be within the operating temperature of the transducers.
- Press ENTER.

9.1.3 Other parameters

Transducer parameter

If transducers are identified at a measuring channel, the input of parameters is finished.

- Press ENTER. The main menu will be displayed.

If no or special transducers are connected, the transducer parameters have to be entered.

```
Parameter\Transducer Type
```

- Select `Standard` to use the standard transducer parameters stored in the transmitter.
- Select `Special Version` to enter the transducer parameters. The transducer parameters have to be provided by FLEXIM.
- Press ENTER.

Notice!

If a standard transducer is selected, no transducer-specific calibration values are considered. A higher uncertainty has to be expected.

```
Parameter\Transducer Type\Special Version
```

If `Special Version` is selected, enter the 6 transducer parameters specified by FLEXIM. Press ENTER after each input.

Extension cable

```
Parameter\Additional cable
```

In case the transducer cable is extended (e.g., between junction box and transmitter), enter the length of the extension cable.

- Select the menu item `Additional cable` in the program branch `Parameter`.
- Enter the length of the extension cable.
- Press ENTER.

9.2 Measurement settings

9.2.1 Selection of the physical quantity and the unit of measurement

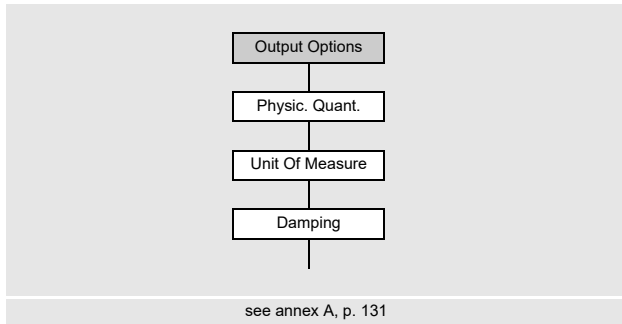

The following physical quantities can be measured:

- sound speed
- flow velocity: is calculated on the basis of the measured transit time difference
- Volumetric flow rate: is calculated by multiplying the flow velocity by the cross-sectional pipe area
- mass flow rate: is calculated by multiplying the volumetric flow rate by the operating density of the fluid

The physical quantity is selected as follows:

- Select the program branch `Output Options`.
- Press ENTER.

```
Output Options\Physic. Quant.
```

- Select the physical quantity in the scroll list.
- Press ENTER.

```
Output Options\Physic. Quant.\Volume flow
```

For the selected physical quantity (except for the sound speed), a scroll list with the available units of measurement is displayed. The unit of measurement which was selected previously is displayed first.

- Select the unit of measurement of the selected physical quantity.
- Press ENTER.

Notice!

If the physical quantity or the unit of measurement is changed, the settings of the outputs have to be checked, see section 9.2.3.

9.2.2 Input of the damping factor

Each displayed measured value is a floating average of all measured values of the last x seconds, with x being the damping factor. A damping factor of 1 s means that the measured values are not averaged because the measuring rate is approx. 1/s. The default value of 10 s is appropriate for normal flow conditions. Values which fluctuate strongly due to a higher flow dynamic, require a higher damping factor.

```
Output Options\...\Damping
```

- Select the program branch `Output Options`.
- Press ENTER until the menu item `Damping` is displayed.
- Enter the damping factor.
- Press ENTER.
- Press key BRK to return to the main menu.

9.2.3 Installation of an output

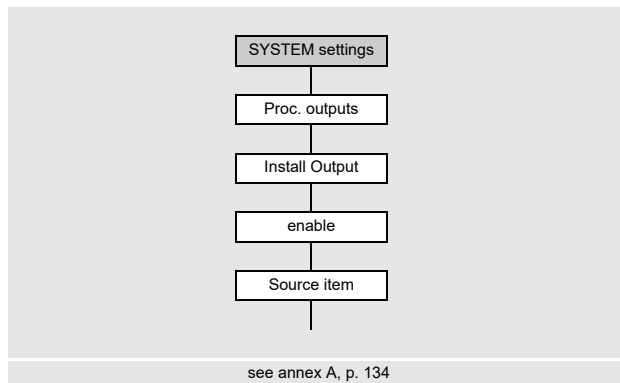

If the transmitter is equipped with outputs, they have to be installed and activated before they can be used:

- assignment of the physical quantity (source item) to be transmitted to the output by the source channel, and the properties of the signal
- definition of the output behavior in case no valid measured values are available
- activation of the installed output in the program branch
Output Options

Notice!

The settings will be stored at the end of the dialog. If the menu item is quit by pressing key BRK, the changes will not be stored.

```
Special Funct.\SYSTEM settings\Proc. outputs
```

- Select `Special Funct.\SYSTEM settings\Proc. outputs`.
- Press ENTER.

Selection of an output

```
Special Funct.\SYSTEM settings\Proc. outputs\Install Output
```

- Select the output to be installed.
- Press ENTER.

The scroll list contains all available outputs of the transmitter:

- Current Ix (--)
- Binary Bx (--)

A tick (✓) after a list item indicates that this output has already been installed.

```
Special Funct.\SYSTEM settings\Proc. outputs\enable I1
```

- Select `yes` to install or reconfigure the output.
- Press ENTER.
- Select `no` to uninstall the output and to return to the previous menu item in order to select another output.
- Press ENTER.

Assignment of a source item

One source item has to be assigned to each selected output.

```
Special Funct.\SYSTEM settings\Proc. outputs\...\Source item
```

- Select the physical quantity (source item) to be transmitted to the output by the source channel.
- Press ENTER.

If a binary output is configured, only the list items `Limit` and `Impuls` will be displayed.

The source items and their scroll lists are summarized in the Tab. 9.1.

Tab. 9.1: Configuration of the outputs

| source item | list item | output |
|-----------------|------------------|--|
| Measuring value | actual measure | physical quantity selected in the program branch Output Options |
| | Flow | flow, independent of the physical quantity selected in the program branch Output Options |
| Quantity | Q+ | totalizer for the positive flow direction |
| | * actual measure | totalizer for the physical quantity selected in the program branch Output Options |
| | * Flow | flow totalizer |
| | Q- | totalizer for the negative flow direction |
| | * actual measure | totalizer for the physical quantity selected in the program branch Output Options |
| | * Flow | flow totalizer |
| Limit | R1 | limit message (Alarm Output R1) |
| | R2 | limit message (Alarm Output R2) |
| | R3 | limit message (Alarm Output R3) |
| Impuls | from abs (x) | pulse without sign consideration |
| | from x > 0 | pulse for positive measured values |
| | from x < 0 | pulse for negative measured values |
| Miscellaneous | c-Medium | sound speed of the fluid |
| | SCNR | ratio useful signal to correlated noise signal |
| | Signal | signal amplitude of a measuring channel |
| | VariAmp | standard deviation of the signal amplitude |
| | Density | density of the fluid |
| | Pressure | pressure of the fluid |

9.2.3.1 Output of the measured value

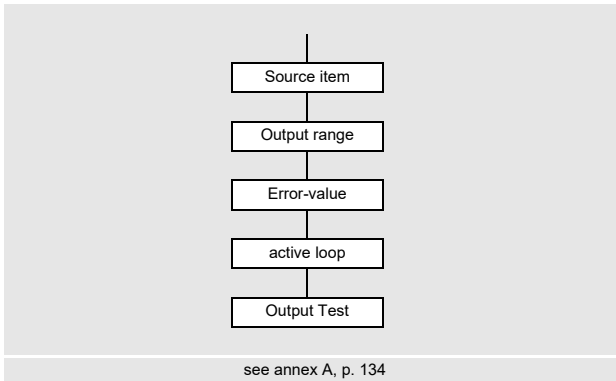

Output range

When configuring an analog output, the output range has to be defined.

```
Special Funct.\SYSTEM settings\  
Proc. outputs\...\Output range I1
```

- Select the menu item Special Funct.\SYSTEM settings\Proc. outputs\...\Output range I1.
- Press ENTER.

- Select a list item.

- 4/20 mA
- other range

- Press ENTER.
- If other range is selected, enter the values Output MIN and Output MAX.
- Press ENTER after each input.

Error output

```
Special Funct.\SYSTEM settings\  
Proc. outputs\...\Error-value I1
```

In the following dialog, an error value can be defined which is to be transmitted if the source item cannot be measured, e.g., if there are solids in the fluid.

- Select a list item for the error output, see Tab. 9.2.
- Press ENTER.
- If Other value is selected, enter an error value. The value has to be within the output range.
- Press ENTER.

Notice!

The settings will be stored at the end of the dialog.

Tab. 9.2: Error output

| error value | result |
|-----------------|---|
| Minimum | the lower limit of the output range is output |
| Hold last value | the last measured value is output |
| Maximum | the upper limit of the output range is output |
| Other value | The value has to be entered manually. It has to be within the limits of the output. |

Example

source item: volumetric flow rate
output: current output
output range: 4...20 mA

error delay: $t_d > 0$

(see section 9.2.5 and Tab. 9.3)

The volumetric flow rate cannot be measured during the time interval $t_0...t_1$. The error value will be output.

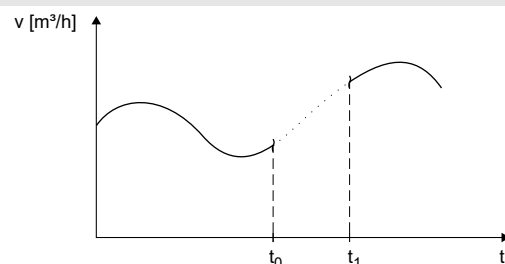

Tab. 9.3: Examples for the error output (output range: 4...20 mA)

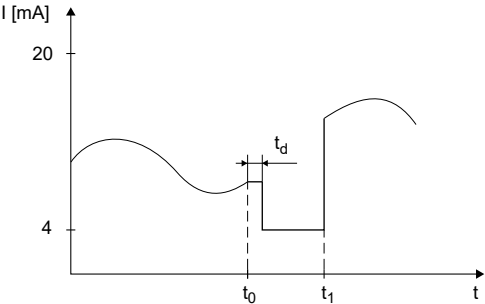
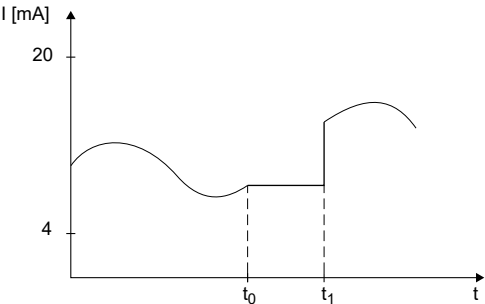
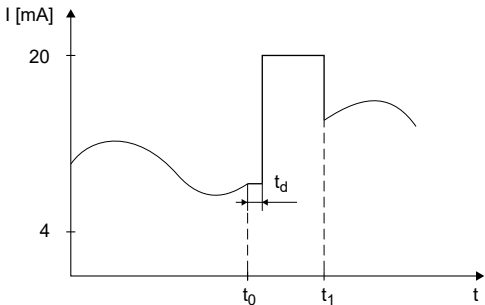
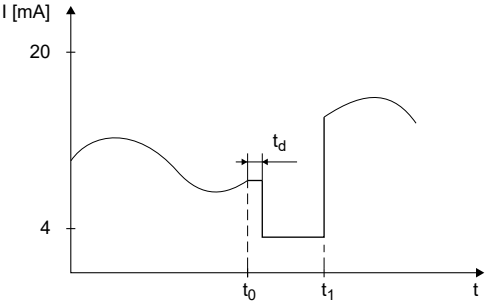
| list item | output signal |
|--|--|
| Minimum (4.0 mA) |  |
| Hold last value |  |
| Maximum (20.0 mA) |  |
| Other value... error value = 3.5 mA |  |

Terminal assignment

Special Funct.\SYSTEM settings\Proc. outputs\...\active loop I1

The terminals for the connection of the output are displayed.

- Press ENTER.

It will be displayed whether the current output is active or passive (here: active).

Output function test

The function of the output can now be tested.

- Connect an external measuring instrument to the terminals of the output.

```
Special Funct.\SYSTEM settings\Proc. outputs\...\Output Test I1
```

- Enter a test value. It has to be within the output range.
- Press ENTER.

```
Special Funct.\SYSTEM settings\Proc. outputs\...\I1= 10 mA\Again?
```

If the external measuring instrument displays the entered value, the output functions correctly.

- Select `yes` to repeat the test, `no` to return to the menu item `SYSTEM settings`.
- Press ENTER.

9.2.4 Activation of an analog output

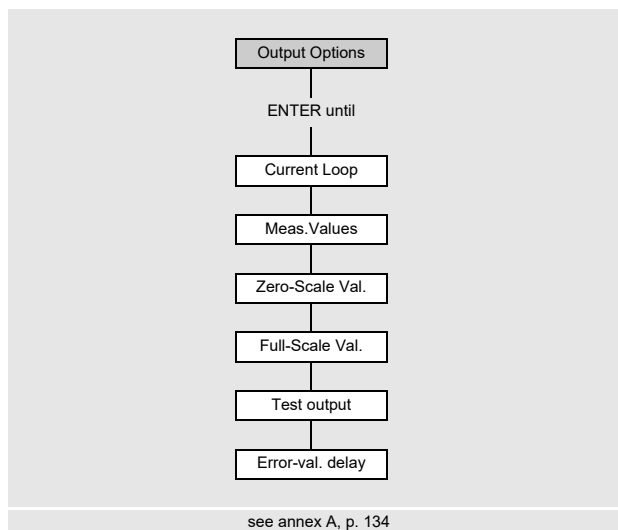

Notice!

An output can only be activated in the program branch `Output Options` if it has previously been installed.

The measuring range of the source item has to be entered.

```
Output Options\...\Current Loop
```

- Press ENTER until `Current Loop` is displayed. Select `yes` to activate the output.
- Press ENTER.

Measuring range

After an analog output has been activated in the program branch `Output Options`, the measuring range of the source item has to be entered.

```
Output Options\...\Meas.Values
```

- Select `sign` if the sign of the measured values is to be considered for the output.
- Select `absolut` if the sign of the measured values is not to be considered for the output.
- Press ENTER.

```
Output Options\...\Zero-Scale Val.
```

- Enter the lowest expected measured value. The unit of measurement of the source item will be displayed. `Zero-Scale Val.` is the value assigned to the value `Output MIN` of the output range.
- Press ENTER.

```
Output Options\...\Full-Scale Val.
```

- Enter the highest expected measured value. The unit of measurement of the source item will be displayed.

Full-Scale Val. is the value assigned to the value Output MAX of the output range.

- Press ENTER.

Example

```
output: current output
output range: 4...20 mA
Zero-Scale Val.: 0 m³/h
Full-Scale Val.: 300 m³/h
volumetric flow rate = 0 m³/h, corresponds to 4 mA
volumetric flow rate = 300 m³/h, corresponds to 20 mA
```

Function test

The function of the output can now be tested.

- Connect an external measuring instrument to the terminals of the output.

```
Output Options\...\I1:Test output?
```

- Select *yes* to test the output.
- Press ENTER.

```
Output Options\...\I1:Test value
```

- Enter a test value for the selected physical quantity. If the external measuring instrument displays the entered value, the output functions correctly.
- Press ENTER.

```
Output Options\...\I1:Test output?
```

- Select *yes* to repeat the test.
- Press ENTER.

Example

```
output: current output
output range: 4...20 mA
Zero-Scale Val.: 0 m³/h
Full-Scale Val.: 300 m³/h
Test value = 150 m³/h (center of the measuring range, corresponds to 12 mA)
If the multimeter displays 12 mA, the current output functions correctly.
```

9.2.5 Input of the error delay

The error delay is the time after which an error value will be sent to an output if no valid measured values are available.

```
Output Options\...\I1:Error-val. delay
```

This display will only be indicated if the list item `edit` is selected in `Special Funct.\Dialogs/Menus/Error-val. delay`.

If the error delay is not entered, the damping factor will be used.

- Enter a value for the error delay.
- Press ENTER.

9.3 Start of the measurement

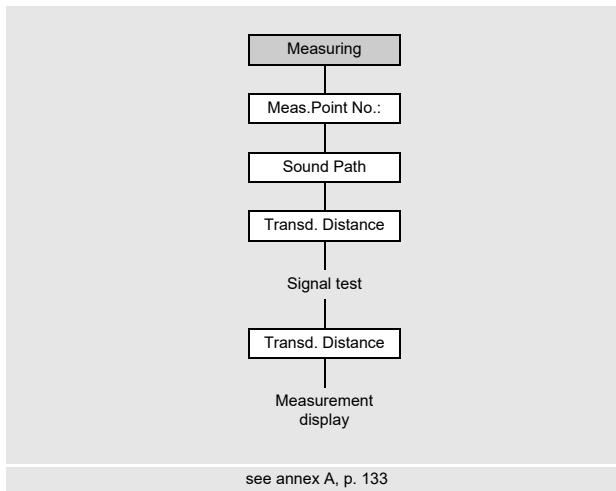

- Select the program branch `Measuring`.
- Press ENTER.

If the parameters in the program branch `Parameter` are not valid or incomplete, the error message `NO DATA!` will be displayed.

If the transmitter has a RS485 interface or the data logger is activated, the measuring point number has to be entered:

Input of the measuring point number

```
Measuring\Channel\Meas.Point No.:
```

- Enter the number of the measuring point.
- Press ENTER.

For the activation of text input, see `Special Funct.\SYSTEM settings Dialogs/Menus/Meas.Point No.:`

Notice!

If the NoiseTrek parallel beam mode is enabled, it will be displayed and the measurement is immediately started.

Input of the sound path number

```
Measuring\Channel\...\Sound Path
```

A value for the number of sound paths corresponding to the connected transducers and the entered parameters is recommended.

- Change the value, if necessary.
- Press ENTER.

Profile correction

If **With disturbance** is selected in the menu item `Special Funct.\SYSTEM settings\
Measuring\ProfileCorr 2.0`, it has to be checked whether the measurement arrangement is appropriate.

If the number of sound paths is odd and more than one measuring channel is activated, the following display appears:

```
A: Alone at measp  
>NO<          yes
```

- Select `no` if there are 2 transducer pairs in X arrangement or displaced X arrangement at the measuring point (appropriate measurement arrangement). The profile correction 2.0 at non ideal inflow conditions will be used. Transverse flow effects will be compensated.
- Select `yes` if there is only one transducer pair at the measuring point (inappropriate measurement arrangement). The profile correction 2.0 at non ideal inflow conditions cannot be used. The profile correction 2.0 at ideal inflow conditions will be used. Transverse flow effects will not be compensated.
- Press ENTER.

If `yes` is selected, the following menu messages are displayed:

```
Disturb correct.  
not applicable!
```

```
I assume ideal  
inlet conditions
```

Adjustment of the transducer distance

```
Measuring\...\Transd. Distance
```

The recommended transducer distance will be displayed.

- Mount the transducers on the pipe adjusting the transducer distance.
- Press ENTER.

```
Reflec – reflection arrangement  
Diagon – diagonal arrangement
```

The transducer distance is measured between the inner edges of the transducers.

In case of a measurement in diagonal mode on very small pipes, a negative transducer distance is possible.

Notice!

The accuracy of the recommended transducer distance depends on the accuracy of the entered pipe and fluid parameters.

The diagnostics window is displayed, see Fig. 9.1.

Fine adjustment of the transducer distance

- If the displayed transducer distance is adjusted, press ENTER.

The measuring run for the positioning of the transducers is started.

The bar graph `S=` shows the amplitude of the received signal, see Fig. 9.1.

- Shift one of the transducers slightly within the range of the recommended transducer distance until the bar graph reaches the max. length (6 squares).
- `■<>■` transducer distance
- `time`: transit time of the measuring signal in μ s
- `S`: signal amplitude
- `Q`: signal quality, bar graph has to have max. length

If the signal is not sufficient for a measurement, `Q= UNDEF` will be displayed.

Fig. 9.1: Diagnostics window

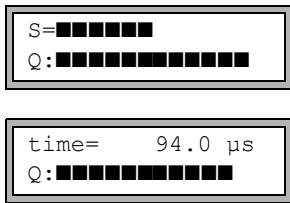

In case of large deviations, check if the entered parameters are correct or repeat the measurement at a different point on the pipe.

```
Measuring\...\Transd. Distance\54 mm
```

After the precise transducer positioning, the recommended transducer distance is displayed again.

- Enter the current (exact) transducer distance.
- Press ENTER.

Afterwards, the measurement will be started automatically.

Consistency check

If a wide range for the sound speed has been entered in the program branch *Parameter* or the exact parameters of the fluid are unknown, a consistency check is recommended.

The transducer distance can be displayed during the measurement by scrolling the key

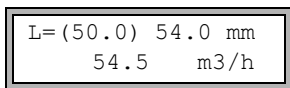

The optimum transducer distance is displayed in brackets (here: 50.0 mm) in the upper line, followed by the entered transducer distance (here: 54.0 mm). The latter value has to correspond to the adjusted transducer distance.

- Press ENTER to optimize the transducer distance.

The optimum transducer distance is calculated on the basis of the measured sound speed. It is therefore a better approximation than the first recommended value which had been calculated on the basis of the sound speed range entered in the program branch *Parameter*.

If the difference between the optimum and entered transducer distance is less than specified in Tab. 9.4, the measurement is consistent and the measured values are valid. The measurement can be continued.

- If the difference is greater, adjust the transducer distance to the displayed optimum value.
- Afterwards, check the signal quality and the signal amplitude bar graph.
- Press ENTER.

Tab. 9.4: Standard values for signal optimization

| transducer frequency | max. difference between the optimum and the entered transducer distance [mm] |
|----------------------|--|
| K | 15 |
| M | 10 |
| P | 8 |
| Q | 6 |

Notice!
If the transducer distance is changed during the measurement, the consistency check has to be repeated once again.

9.4 Display of measured values

The measured values are displayed during the measurement as follows:

```

    Volume flow
      31.82   m3/h
    
```

9.4.1 Value of the sound speed

The sound speed of the fluid can be displayed during the measurement by pressing key .

If an approximate range for the sound speed has been entered in the program branch `Parameter` and the transducer distance has been optimized afterwards, it is recommended to write down the sound speed for the next measurement. By doing this, it will not be necessary to repeat the fine adjustment.

Write down the fluid temperature as the sound speed depends on it. The value can be entered in the program branch `Parameter`.

9.4.2 Adjustment of the display



During the measurement, the display can be adapted in order to display 2 measured values at the same time (one in each line of the display). This does not affect totalizing, storing of measured values, transmission of measured values, etc.

The following information can be displayed in the upper line:

| display | explanation |
|-----------|--|
| Mass Flow | designation of the physical quantity |
| +8.879 m³ | values of the totalizers, if activated |
| full | date and time at which the data logger will be full, if activated |
| Mode | measuring mode |
| L | transducer distance |
| Rx | alarm state indication if activated and if alarm outputs are activated |

The measured values of the physical quantity selected in the program branch `Output Options` can be displayed in the lower line:

| display | explanation |
|----------|----------------------|
| 12.3 m/s | flow velocity |
| 1423 m/s | sound speed |
| 124 kg/h | mass flow rate |
| 15 m3/h | volumetric flow rate |

Press key  during the measurement to change the display in the upper line, press key  to change the display in the lower line.

```

    Flow Velocity
    *   2.47   m/s
    
```

The character * indicates that the displayed value (here: flow velocity) is not the selected physical quantity.

Status line

Important information of the running measurement is summarized in the status line. Quality and precision of the running measurement can be evaluated accordingly.

Press key  during the measurement to scroll through the upper line to the status line.

Fig. 9.2: Display of the status line



Tab. 9.5: Description of the status line

| | value | explanation |
|---|-----------------------------|---|
| S | | signal amplitude |
| | 0 | < 5 % |
| | ... | ... |
| | 9 | ≥ 90 % |
| Q | | signal quality |
| | 0 | < 5 % |
| | ... | ... |
| | 9 | ≥ 90 % |
| c | | sound speed comparison of the measured and the expected sound speed of the fluid The expected sound speed is calculated from the fluid parameters. |
| | √ | OK, is equal to the expected value |
| | ↑ | > 20 % of the expected value |
| | ↓ | < 20 % of the expected value |
| | ? | unknown, cannot be measured |
| R | | flow profile information about the flow profile based on the Reynolds number |
| | T | fully turbulent flow profile |
| | L | fully laminar flow profile |
| | ↑↓ | transition range between laminar and turbulent flow |
| | ? | unknown, cannot be calculated |
| F | | flow velocity comparison of the measured flow velocity with the flow limits of the system |
| | √ | OK, the flow velocity is not within the critical range |
| | ↑ | the flow velocity is higher than the current limit |
| | ↓ | the flow velocity is lower than the current cut-off flow |
| | 0 | the flow velocity is within the limit range of the measuring method |
| ? | unknown, cannot be measured | |

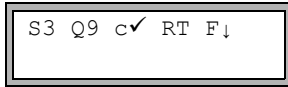
9.4.3 Transducer distance

The transducer distance can be displayed during the measurement by scrolling the key .

Fig. 9.3: Display of the transducer distance

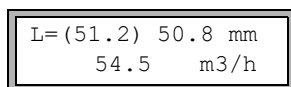

The optimum transducer distance (here: 51.2 mm) will be displayed in parentheses in the upper line, followed by the entered transducer distance (here: 50.8 mm).

The optimum transducer distance might change during the measurement (e.g., due to temperature fluctuations).

A deviation from the optimum transducer distance (here: 0.4 mm) will be compensated internally.

| |
|--|
| Notice! |
| Never change the transducer distance during the measurement. |

9.5 Execution of special functions

Commands that can be executed during a measurement are displayed in the upper line.

A command begins with →. If programmed, a program code has to be entered first.

- Press key  until the command is displayed.
- Press ENTER.

The commands available are the following:

Tab. 9.6: Executable commands during the measurement

| command | explanation |
|------------------|---|
| →Adjust transd. | toggling to transducer positioning If a program code is active, the measurement will be continued 8 s after the last keyboard entry. |
| →Clear totalizer | reset of flow totalizers to zero |
| →Break measure | stop of the measurement and return to the main menu |

9.6 Determination of the flow direction

The flow direction in the pipe can be detected with the help of the displayed volumetric flow rate sign in conjunction with the arrow on the transducers:

- The fluid flows in the direction of the arrow if the displayed volumetric flow rate is positive (e.g., 54.5 m³/h).
- The fluid flows against the arrow direction if the displayed volumetric flow rate is negative (e.g., -54.5 m³/h).

9.7 Stop of the measurement

The measurement is interrupted by pressing key BRK if it is not protected by a program code, see section 18.5.

| |
|---|
| Notice! |
| Be careful not to stop a current measurement by inadvertently pressing key BRK. |

10 Troubleshooting

Warning!



Service works by unauthorized and unqualified personnel

This may result in personal or material damage or other dangerous situations.
→ Any work on the transmitter has to be carried out by authorized and qualified personnel.

Caution!



Safety and accident prevention regulations for electrical systems and equipment

Failure to observe these regulations may lead to death or severe injury.
→ Observe the safety and accident prevention regulations for electrical systems and equipment.

Warning!



Touching live parts

Electric shock or arc faults can lead to severe injuries. The measuring equipment can be damaged.
→ Prior to any work on the transmitter (e.g., installation, dismantling, connection, start-up), the transmitter has to be disconnected from the power supply. It is not sufficient to remove the internal fuse of the instrument, see section 7.2.

Caution!



Touching hot or cold surfaces

This may result in injuries (e.g., thermal damages).
→ Observe the ambient conditions at the measuring point during installation. Wear the required personal protective equipment. Observe the applicable rules.

If any problem appears which cannot be solved with the help of this operating instruction, contact our sales office and give a precise description of the problem. Specify the type, the serial number and the firmware version of the transmitter.

The display does not work at all or fails regularly

Check the contrast setting of the transmitter or enter the HotCode **555000** to set the display to medium contrast.

Make sure that the correct voltage is available at the terminals. The destined transmitter voltage is indicated on the nameplate below the outer right terminal.

If the power supply is OK, the transducers or an internal component of the transmitter are defective. The transducers and the transmitter have to be sent to FLEXIM for repair.

The message "SYSTEM ERROR" is displayed

Press key BRK to return to the main menu.

If this message is displayed repeatedly, write down the number displayed in the lower line. Track down the situations when the error is displayed. Contact FLEXIM.

The transmitter does not react when key BRK is pressed during the measurement

The program code is activated. Press key C and enter the program code.

The backlight of the display does not work, but all other functions are available

The backlight is defective. This problem has no influence on other functions of the display. Send the transmitter to FLEXIM for repair.

Date and time are wrong, the measured values are deleted when the transmitter is switched off

The data backup battery has to be replaced if the date and the time are reset or wrong or the measured values are deleted after the transmitter has been switched off and on. Send the transmitter to FLEXIM.

An output does not work

Make sure that the outputs are configured correctly. Check the function of the output. If the output is defective, contact FLEXIM.

10.1 Problems with the measurement

A measurement is not possible because no signal is received. A question mark is displayed after the physical quantity.

- Check whether the entered parameters are correct, especially the outer pipe diameter, the pipe wall thickness and the sound speed of the fluid. Typical errors: The circumference or the radius was entered instead of the diameter. The inner pipe diameter was entered instead of the outer pipe diameter.
- Check the number of sound paths.
- Make sure that the recommended transducer distance was adjusted when mounting the transducers.
- Make sure that an appropriate measuring point is selected and the number of sound paths was entered correctly.
- Try to establish a better acoustic contact between the pipe and the transducers.
- Enter a lower value for the number of sound paths. The signal attenuation might be too high due to a high fluid viscosity or deposits on the inner pipe wall.

The measuring signal is received but no measured values can be obtained

- A exclamation point (!) in the lower line on the right indicates that the defined upper limit of the flow velocity is exceeded and, therefore, the measured values are marked as invalid. The limit has to be adapted to the measuring conditions or the check has to be deactivated.
- If no exclamation point is displayed, a measurement at the selected measuring point is impossible.

Signal loss during the measurement

- If there is no measuring signal after the pipe had been run empty and refilled, contact FLEXIM.
- Wait a moment until the acoustic contact is reestablished. The measurement can be interrupted due to a temporarily higher proportion of gas bubbles and solids in the fluid.

The measured values substantially differ from the expected values

- Wrong measured values are often caused by wrong parameters. Make sure that the entered parameters are correct for the measuring point.

10.2 Measuring point selection

- Make sure that the recommended min. distance to any disturbance source is observed.
- Avoid measuring points with deposit formation in the pipe.
- Avoid measuring points in the vicinity of deformations and defects on the pipe as well as welds.
- Make sure the pipe surface at the selected measuring point is even.
- Measure the temperature at the measuring point and make sure that the transducers are suitable for this temperature.
- Make sure that the outer pipe diameter is within the measuring range of the transducers.
- When measuring on a horizontal pipe, the transducers have to be mounted laterally on the pipe.
- The measuring point on a vertically mounted pipe has always to be filled. The fluid should flow upward.
- No gas bubbles should form (even bubble-free fluids can form gas bubbles when the fluid expands, e.g., upstream of pumps and downstream of great cross-section enlargements).

10.3 Maximum acoustic contact

see section 6.2.

10.4 Application-specific problems

A fluid with a wrong sound speed was selected

If the selected sound speed in the fluid does not match the actual one, the transducer distance can probably not be determined correctly.

The fluid sound speed is used to calculate the transducer distance and is therefore very important for the transducer positioning. The sound speeds stored in the transmitter only serve as an orientation.

The entered pipe roughness is not appropriate

Check the entered value. The pipe state should be considered.

Measurements on pipes made of porous materials (e.g., concrete or cast iron) are only conditionally possible

Contact FLEXIM.

The pipe lining may cause problems during the measurement if it is not firmly attached to the inner pipe wall or consists of acoustically absorbing material

Try to measure on a section of the pipe free from lining.

Highly viscous fluids strongly attenuate the ultrasonic signal

The measurement of fluids with a viscosity of $> 1000 \text{ mm}^2/\text{s}$ is only conditionally possible.

A high concentration of gases or solids in the fluid scatter and absorb the ultrasonic signal and thus attenuate the measuring signal

A measurement is impossible if the value is $\geq 10 \%$. If the proportion is high, but $< 10 \%$, a measurement is only conditionally possible.

10.5 Significant deviations of the measured values

A fluid with a wrong sound speed was selected

If a fluid was selected whose sound speed does not match the actual one, the measuring signal may be confused with the pipe wall signal.

The flow calculated on the basis of the wrong signal by the transmitter is very small or fluctuates around zero.

There is gas in the pipe

If there is gas in the pipe, the measured flow will be too high because both, the liquid and gas volume, are measured.

The defined upper limit of the flow velocity is too low

All measured flow velocities that are greater than the upper limit will be ignored and marked as invalid. All quantities deviated from the flow velocity will also be indicated as invalid. If several correct measured values are ignored, the totalizer values will be too low.

The entered cut-off flow is too high

All flow velocities below the cut-off flow are set to zero. All derived quantities are also set to zero. The cut-off flow has to be set to a low value to be able to measure at low flow velocities (default: 2.5 cm/s).

The entered pipe roughness is not appropriate

The flow velocity of the fluid is outside the measuring range of the transmitter

The measuring point is not appropriate

Check whether a different measuring point provides better results. Because pipes are never rotationally symmetric, the flow profile is affected.

10.6 Problems with the totalizers

The values of the totalizers are too high

See `Special Funct.\SYSTEM settings\Measuring\Quantity recall`. If this menu item is activated, the values of the totalizer will be stored. The totalizer will continue with this value at the start of the next measurement.

The values of the totalizers are too small

One of the totalizers has reached the upper limit and has to be reset to zero manually.

The sum of the totalizers is not correct

See `Special Funct.\SYSTEM settings\Measuring\Quant. wrapping`. The sum of both totalizers (throughput) transmitted via the output is no longer valid after the first overflow (wrapping) of one of the totalizers.

11 Maintenance and cleaning

Warning!



Service works by unauthorized and unqualified personnel
 This may result in personal or material damage or other dangerous situations.
 → Any work on the transmitter has to be carried out by authorized and qualified personnel.

Warning!



Touching live parts
 Electric shock or arc faults can led to severe injuries. The measuring equipment can be damaged.
 → Prior to any work on the transmitter (e.g., installation, dismounting, connection, start-up), the transmitter has to be disconnected from the power supply. It is not sufficient to remove the internal fuse of the instrument, see section 7.2.

Caution!



Safety and accident prevention regulations for electrical systems and equipment
 Failure to observe these regulations may lead to death or severe injury.
 → Observe the safety and accident prevention regulations for electrical systems and equipment.

Caution!



Touching hot or cold surfaces
 This may result in injuries (e.g., thermal damages).
 → Observe the ambient conditions at the measuring point during installation. Wear the required personal protective equipment. Observe the applicable rules.

11.1 Maintenance

The transmitter and the transducers are practically maintenance-free. In order to ensure security, the following maintenance intervals are recommended:

| item | maintenance step | interval | measure |
|--|--|---|--|
| stainless steel housing • junction box • transducer mounting fixture | visual inspection for corrosion and damages | annually | cleaning, see section 11.2 |
| | visual inspection for contamination | annually, depending on the ambient conditions more frequently | |
| aluminum housing • transmitter | visual inspection for contamination | annually, depending on the ambient conditions more frequently | |
| transducers | check of the transducer coupling on the tube | annually | replacement of coupling foil, if necessary |
| transmitter | firmware check for updates | annually | update, if necessary |
| transmitter | functional test | annually | reading of measured and diagnostic values |
| transmitter and transducers | calibration | - | see section 11.3 |

11.2 Cleaning

Stainless steel housing

- Clean the housing using a soft cloth and care and cleaning spray for stainless steel.

Aluminum housing

- Clean the housing with a soft cloth. Do not use detergents.

Transducers

- Remove traces of coupling compound from the transducers with a soft paper towel.

11.3 Calibration

If installed as recommended in an appropriate location, used cautiously and serviced conscientiously, no troubles should appear.

The transmitter has been calibrated at factory and, usually, a re-calibration of the transmitter is not necessary.

A re-calibration is recommended if:

- the contact surface of the transducers show visible wear or
- the transducers were used for a prolonged period at high temperatures (several months > 130 °C for normal transducers or > 200 °C for high temperature transducers)

In order to realize a recalibration under reference conditions either the transmitter, the transducers or the transmitter with transducers have to be sent to FLEXIM depending on which part needs to be calibrated.

12 Dismounting and disposal

Warning!



Installation, connection and start-up by unauthorized and unqualified personnel

This may result in personal or material damage or other dangerous situations.

→ Any work on the transmitter has to be carried out by authorized and qualified personnel.

Warning!



Touching live parts

Electric shock or arc faults can lead to severe injuries. The measuring equipment can be damaged.

→ Prior to any work on the transmitter (e.g., installation, dismantling, connection, start-up), the transmitter has to be disconnected from the power supply. It is not sufficient to remove the internal fuse of the instrument, see section 7.2.

Caution!



Safety and accident prevention regulations for electrical systems and equipment

Failure to observe these regulations may lead to death or severe injury.

→ Observe the safety and accident prevention regulations for electrical systems and equipment.

12.1 Dismounting

The dismantling is carried out in reverse order to its installation, see chapter 6.

12.2 Disposal

The measuring equipment has to be disposed in accordance to the applicable regulations.

Depending on the material, the corresponding parts have to be disposed in residual or special waste or recycled. For further information, contact FLEXIM.

13 Outputs

In addition to the analog outputs, the transmitter can be equipped with binary outputs.

13.1 Installation of a binary output

If the transmitter is equipped with binary outputs, they have to be installed and activated before they can be used:

- assignment of the physical quantity (source item) to be transmitted to the output by the source channel, and the properties of the signal
- activation of the installed binary output in the program branch `Output Options`

Notice!

The settings will be stored at the end of the dialog. If the menu item is quit by pressing key BRK, the changes will not be stored.

```
Special Funct.\SYSTEM settings\Proc. outputs
```

- Select the menu item `Special Funct.\SYSTEM settings\Proc. outputs`.
- Press ENTER.

Selection of a binary output

```
Special Funct.\SYSTEM settings\Proc. outputs\Install Output
```

- Select the binary output to be installed.
- Press ENTER.

```
Special Funct.\SYSTEM settings\Proc. outputs\enable B1
```

- Select `yes` to install or reconfigure the output.
- Press ENTER.
- Select `no` to uninstall the output and to return to the previous menu item in order to select another output.
- Press ENTER.

Assignment of a source item

One source item has to be assigned to each selected output.

```
Special Funct.\SYSTEM settings\Proc. outputs\...\Source item
```

- Select the physical quantity (source item) to be transmitted to the binary output by the source channel.
- Press ENTER.

The source items and their scroll lists are summarized in the following table.

Fig. 13.1: Configuration of the binary outputs

| source item | list item | output |
|-------------|-------------|---|
| Limit | R1 | limit message (Alarm Output R1) |
| | R2 | limit message (Alarm Output R2) |
| | R3 | limit message (Alarm Output R3) |
| Impuls | from abs(x) | pulse without sign consideration |
| | from x > 0 | pulse for positive measured values of the volumetric flow rate |
| | from x < 0 | pulse for negative measured values for the volumetric flow rate |

Function test of the binary output

The function of the output can now be tested.

- Connect an external measuring instrument to the terminals of the output.

```
Special Funct.\SYSTEM settings\Proc. outputs\...\Output Test B1\Opto-Relay OFF
```

- Select `Opto-Relay OFF` in the scroll list `Output Test` to test the de-energized state of the output.
- Press ENTER. Measure the resistance at the output. The value has to be high ohmic.

```
Special Funct.\...\Output Test B1\B1=ON\Again?
```

- Select `yes` to repeat the test, `no` to return to the menu item `SYSTEM settings`.
- Press ENTER.

```
Special Funct.\SYSTEM settings\Proc. outputs\...\Output Test B1\Opto-Relay ON
```

- Select `Opto-Relay ON` in the scroll list `Output Test` to test the energized state of the output.
- Press ENTER. Measure the resistance at the output. The value has to be low ohmic.

```
Special Funct.\...\Output Test B1\B1=ON\Again?
```

- Select `yes` to repeat the test, `no` to return to the menu item `SYSTEM settings`.
- Press ENTER.

13.2 Activation of a binary output as pulse output

A pulse output is an integrating output which emits a pulse when the volume or the mass of the fluid which has passed the measuring point reaches a given value (`Pulse Value`). The integrated quantity is the selected physical quantity. Integration is restarted as soon as a pulse is emitted.

Notice!

The menu item `Pulse Output` will only be indicated in the program branch `Output Options` if a pulse output has been installed.

```
Output Options\...\Pulse Output
```

- Press ENTER until `Pulse Output` is displayed.
- Select `yes` to activate the output.
- Press ENTER.

```
Output Options\...\Pulse Output\NO COUNTING
```

This error message will be displayed if the flow velocity is selected as the physical quantity.

The use of the pulse output is not possible in this case because the integration of the flow velocity does not result in a reasonable value.

```
Output Options\...\Pulse Output\Pulse Value
```

- Enter the pulse value. The unit of measurement will be displayed according to the actual physical quantity. When the counted physical quantity reaches the entered pulse value, a pulse will be transmitted.
- Press ENTER.

Output Options\...\Pulse Output\Pulse Width

- Enter the pulse width.

The range of possible pulse widths depends on the specification of the instrument (e.g., counter, PLC) that is to be connected to the output.

- Press ENTER.

The max. flow the pulse output can work with will be displayed now. This value is calculated on the basis of the entered pulse value and pulse width.

If the flow exceeds this value, the pulse output does not work correctly. In this case, the pulse value has to be increased.

- Press ENTER.

14 Data logger

The transmitter has a data logger which stores the following data during the measurement:

- date
- time
- measuring point number
- pipe parameters
- fluid parameter
- transducer data
- sound path (reflection or diagonal arrangement)
- transducer distance
- damping factor
- storage rate
- physical quantity
- unit of measurement
- values of the totalizers
- diagnostic values

In order to store the data, the data logger has to be activated.

The available data logger can be displayed.

14.1 Activation/Deactivation of the data logger

```
Output Options\...\Store Meas.Data
```

- Select the program branch `Output Options`.
- Press ENTER until `Store Meas.Data` is displayed.
- Select `yes` to activate the data logger, `no` to deactivate it.
- Press ENTER.

14.2 Setting the storage rate

The storage rate is the frequency to transmit or store measured values. If the storage rate is not set, the storage rate previously selected will be used.

The recommended storage rate is 4 s.

```
Output Options\...\Storage Rate
```

- Select a storage rate or `EXTRA`.
- Press ENTER.

This display will only be indicated if `Store Meas.Data` and/or `Serial Output` are activated.

```
Output Options\...\Storage Rate\EXTRA
```

- Enter the storage rate if `EXTRA` was selected.
- Press ENTER.

14.3 Configuration of the data logger

Special Funct.\SYSTEM settings\Storing

- Select the menu item Special Funct.\SYSTEM settings\Storing.
- Press ENTER.

Starting time

It is possible to set a starting time if it is necessary to synchronize the storing of measured values for several transmitters.

Special Funct.\SYSTEM settings\Storing\Start logger

- Select the moment at which the storing has to start.

| display | description |
|-----------------|---|
| Promptly | The storing starts immediately. |
| On full 5 min. | The storing starts in the next full 5 minutes. |
| On full 10 min. | The storing starts in the next full 10 minutes. |
| On quarter hour | The storing starts in the next full 15 minutes. |
| On half hour | The storing starts in the next full 30 minutes. |
| On full hour | The storing starts in the next full 60 minutes. |

Example

actual time: 09:06 am
 setting: On full 10 min.
 The storing starts at 09:10 am.

Ringbuffer

The setting of the ringbuffer influences the storing of measured values as soon as the data logger is full:

- If the ringbuffer is activated, the available data logger will be halved. The oldest measured values will be overwritten. Only the data logger memory that was free during the activation will be used by the ringbuffer. If more data logger memory is necessary, measured values in the data logger should be previously deleted.
- If the ringbuffer is deactivated, the storing of measured values will be stopped.

Special Funct.\SYSTEM settings\Storing\Ringbuffer

- Select ON to activate the ringbuffer.
- Press ENTER.

Storage mode

Special Funct.\SYSTEM settings\Storing\Storage mode

- Select the storage mode.
- Press ENTER.

If `sample` is selected, the current measured value will be used for the storing and online transmission of data.

If `average` is selected, the average of all values measured during a storage interval will be used for the storing and online transmission of data.

Notice!

The storage mode does not affect the outputs.

Notice!

Storage mode = average

The average of the physical quantity and other measurands assigned to the measuring channel, will be calculated.

If the storage rate < 5 s is selected, `sample` will be used.

If no average could be calculated over the complete storage interval, the value will be marked as invalid. The ASCII file will contain ??? for invalid average values of the data and ?UNDEF instead of invalid temperatures.

Totalizer storing

It is possible to store the currently displayed totalizer only or to store one value for each flow direction.

```
Special Funct.\SYSTEM settings\Storing\Quantity Storage
```

- Select `one` to store the currently displayed totalizer value only. This can apply for the positive and negative totalizer.
- Select `both` to store the totalizer values for both flow directions.
- Press ENTER.

Signal amplitude storing

```
Special Funct.\SYSTEM settings\Storing\Store Amplitude
```

- Select `on` to store the amplitude of the measured signal together with the measured values.
- Press ENTER.

Fluid sound speed storing

```
Special Funct.\SYSTEM settings\Storing\Store c-Medium
```

- Select `on` to store the fluid sound speed together with the measured values.
- Press ENTER.

Diagnostic values storing

```
Special Funct.\SYSTEM settings\Storing\Store diagnostic
```

- Select `on` to store the diagnostic values together with the measured values.
- Press ENTER.

14.4 Measurement with activated data logger

```
Measuring\Channel\Meas.Point No.:
```

- Start the measurement.
- Enter the number of the measuring point.
- Press ENTER.

If `Output Options\Store Meas.Data` is activated and `Special Funct.\SYSTEM settings\Ringbuffer` is deactivated, a message indicating an error will be displayed as soon as the data logger is full.

```
DATA LOGGER IS FULL!
```

- Press ENTER.

The error message will be displayed periodically.

14.5 Deletion of measured values

```
Special Funct.\Delete Meas.Val.
```

- Select the menu item `Special Funct.\Delete Meas.Val.`
- Press ENTER.

```
Special Funct.\Delete Meas.Val.\Really Delete?
```

- Select `yes` or `no`.
- Press ENTER.

14.6 Information relating the data logger

Aprox. 100 000 measurement data can be stored. Each measured value is stored with the corresponding totalizer and optionally further measurement and diagnostic data, see section 14.3.

According to the configuration of the data logger and the stored series of measured values, the available data logger will be displayed in the menu item `Special Funct.\Instrum. Inform.`

```
Special Funct.\Instrum. Inform.
```

- Select the menu item `Special Funct.\Instrum. Inform.`
- Press ENTER.

It is recommended to delete the old series of measured values before starting a measurement, see section 14.5.

Abb. 14.1: Information relating the data logger

```
F501   -xxxxxxxxx
Free   18327
```

The type and the serial number of the transmitter are displayed in the upper line.

The available data logger will be displayed in the lower line (here: 18 327 additional measured values can be stored).

- Press key BRK twice to return to the main menu.

It is possible to store max. 100 series of measured values. The number of series of measured values depends on the total number of measured values stored in the previous series of measured values.

Press key  to scroll through the display of the upper line.

```
full= 26.01/07:39
      54.5   m3/h
```

If the ringbuffer is activated and has overflowed at least once, the following display will be indicated:

```
last= 26.01/07:39
      54.5   m3/h
```

15 Data transmission

The data can be transmitted to the PC via the process interface (RS485 (option) or others) or the service interface (RS232) of the transmitter.

Tab. 15.1: Data transmission overview

| program | data transmission | | see |
|---------------------|-------------------|-------------------|--------------|
| FluxDiagReader | RS232 | offline | section 15.1 |
| FluxDiag (optional) | RS232 | offline or online | section 15.1 |
| terminal program | RS232 or RS485 | offline or online | section 15.2 |

15.1 FluxDiagReader/FluxDiag

With the help of FluxDiagReader and FluxDiag it is possible to display measurement data, snaps and parameter settings on the PC and to export them as csv file. In order to use FluxDiagReader, the measurement has to be stopped.

In addition to this, FluxDiag allows to analyze, to compare and to visualize measurement data as well as to create reports during the measurement. A permanent data transmission via FluxDiag is not recommended.

For the operation of the programs see FluxDiagReader support or FluxDiag support.

For the connection of the service interface, see section 7.4.

15.2 Terminal program

If FluxDiag is not available, the measurement data can be transmitted to a terminal program in ASCII format.

15.2.1 Online transmission

The measured values are transmitted during the measurement.

The data logger works independently of the online transmission but with the same transmission rate.

Notice!

It is recommended to use the RS485 interface for the online transmission of data. The RS232 service interface should only be used if the transmitter does not have an RS485 interface.

- Start the terminal program.
- Enter the transmission parameters into the terminal program. The transmission parameters of the terminal program and the transmitter have to be identical, see section 15.3.

Transmitter settings

- Press ENTER until the menu item `Serial Output` is displayed.
- Select `yes` to activate the online transmission.
- Press ENTER.

```
Output Options\...\Serial Output\SEND ONLINE-HEAD
```

- Enter the storage rate.
- Start the measurement.

15.2.2 Offline transmission

Notice!
During the offline transmission only those data is transmitted that is stored in the transmitter.

- Start the terminal program.
- Enter the transmission parameters into the terminal program. The transmission parameters of the terminal program and the transmitter have to be identical, see section 15.3.
- Selection of the interface for the offline transmission of data

Special Funct.\SYSTEM settings\serial transmis.

- Select the menu item Special Funct.\SYSTEM settings\serial transmis.
- Press ENTER until Send Offline via is displayed.

Special Funct.\SYSTEM settings\serial transmis.\Send Offline via

- Select the serial interface for the offline transmission of data.
- This display will only be indicated if the transmitter has an RS485 interface.

Transmitter settings

Special Funct.\Print Meas.Val.

- Select the menu item Special Funct.\Print Meas.Val.
 - Press ENTER.
- The following message will be displayed if no measured values are stored.

NO VALUES
Print Meas.Val.

- Press ENTER.
- The following message will be displayed if the measurement values are transmitted.

Send Header
.....

The progress of the transmission of data is displayed by a bar graph.

■■■■■■
.....

The following error message will be displayed if an error has occurred during the serial transmission.

SERIAL ERROR
Print Meas.Val.

- Press ENTER.
- Check the connections and make sure the PC is ready to receive data.

15.3 Transmission parameters

- the transmitter sends CRLF-terminated ASCII
- max. line length: 255 digits

RS232

default: 9600 bits/s, 8 data bits, even parity, 2 stop bits, protocol RTS/CTS (hardware, handshake)

The transmission parameters of the RS232 service interface can be changed.

- Enter the HotCode **232-0-**, see section 8.4.

```
BAUD<data par st  
9600 8bit EVEN 2
```

- Set the transmission parameters in the 4 scroll lists.
- Press ENTER.
 - baud: baud rate
 - data: number of data bits
 - par: parity
 - st: number of stop bits

RS485

default: 9600 bit/s, 8 data bits, even parity, 1 stop bit

```
Special Funct.\SYSTEM settings\Network
```

- Select the menu item `Special Funct.\SYSTEM settings\Network` to change the settings of the transmission parameters.
- Press ENTER.

This display will only be indicated if the transmitter has an RS485 interface.

```
Special Funct.\SYSTEM settings\Network\Device address:
```

- Press ENTER to confirm the device address in the network.

```
Special Funct.\SYSTEM settings\Network\RS485 protocol
```

- Select `default` to display the default transmission parameters.
- Select `setup` to change the transmission parameters.
- Press ENTER.

```
BAUD< parity st  
9600 EVEN 2
```

- Set the transmission parameters in the 3 scroll lists.
- Press ENTER.
 - baud: baud rate
 - parity: parity
 - st: number of stop bits

The default transmission parameters will be used if `default` is selected and the transmission parameters have not been changed.

15.4 Data format

```
Special Funct.\SYSTEM settings\serial transmis.\SER:kill spaces
```

- Select the menu item `Special Funct.\SYSTEM settings\serial transmis.`
- Press ENTER until `SER:kill spaces` is displayed.
- Select on if the space characters are not to be transmitted.
- Press ENTER.

The file size will be considerably smaller (shorter transmission time).

```
Special Funct.\SYSTEM settings\serial transmis.\SER:decimalpoint
```

- Select the decimal marker to be used for floating-point numbers (point or comma).
- Press ENTER.

This setting depends on the setting of the operating system of the PC.

```
Special Funct.\SYSTEM settings\serial transmis.\SER:col-separat.
```

- Select the character to be used to separate columns (semicolon or tabulator).
- Press ENTER.

15.5 Data structure

First, the header is transmitted. The first 4 lines contain general information about the transmitter and the measurement. The following lines contain the parameters for each channel.

Example

```
\DEVICE           : F50x -XXXXXXXXX
\MODE             : ONLINE
DATE             : 2018-01-09
TIME            : 19:56:52
Par.Record
Meas.Point No.:  : A:F5050
Pipe
  Outer Diameter : 60.3 mm
  Wall Thickness  : 5.5 mm
  Roughness      : 0.1 mm
  Pipe Material   : Carbon Steel
  Lining         : WITHOUT LINING
Medium          : Water
Medium Temperat. : 38 C
Fluid pressure  : 1.00 bar
Transducer Type : xxx
Sound Path     : 3 NUM
Transd. Distance : -15.6 mm
Damping        : 20 s
Full-Scale Val. : 4.50 m3/h
Physic. Quant. : Volume flow
Unit Of Measure : [m3/h]/[m3]
Numb.Of Meas.Val : 100
```

Next, the line `\DATA` is transmitted. Followed by the column titles, see Tab. 15.2, for the corresponding channel. The measured values are transmitted afterwards.

Example

```
\DATA
A: \*MEASURE; Q_POS; Q_NEG;
B: \*MEASURE; Q_POS; Q_NEG;
```

Depending on the storage interval, one data line per activated measuring channel is transmitted. The line "???" will be transmitted if there are no measured values available for the storage interval.

Example

With a storage interval of 1 s, 10 lines with "???" will be transmitted if the measurement has been restarted after a 10 s interruption for the positioning of the transducers.

The following data columns can be transmitted:

Tab. 15.2: Data columns

| column title | column format | content |
|--------------|---------------|---|
| *MEASURE | ###000000.00 | physical quantity selected in the program branch Output Options |
| Q_POS | +00000000.00 | totalizer value for the positive flow direction |
| Q_NEG | -00000000.00 | totalizer value for the negative flow direction |
| SSPEED | | sound speed of the fluid |
| AMP | | signal amplitude |

Online transmission

Columns will be created for all quantities appearing during the measurement. The columns Q_POS and Q_NEG remain empty if the totalizers are deactivated.

As the totalizers cannot be activated for the physical quantity "flow velocity", these columns will not be generated.

Offline transmission

During the offline transmission of data, columns will only be created if at least one measured value is stored in the data set. The columns Q_POS and Q_NEG will not be generated if the totalizers are deactivated.

16 Advanced functions

16.1 Totalizers

The total volume or total mass of the fluid at the measuring point can be determined.

There are 2 totalizers, one for the positive and the other for the negative flow direction. The unit of measurement used for totalizing corresponds to the volume or mass unit selected for the physical quantity.

The totalizer values can be displayed with up to 11 places, e.g., 74890046.03. For the adjustment of the decimal places (max. 4), see section 17.6.

Display of the totalizer

- Press key  during the measurement to scroll through the upper line and display the totalizers.

| | |
|-------------|------|
| Volume flow | |
| 54.5 | m3/h |

| | |
|------|------|
| 32.5 | m3 |
| 54.5 | m3/h |

The totalizer value will be displayed in the upper line (here: the volume which has passed the measuring point in positive flow direction since the activation of the totalizers).

- Press ENTER while a totalizer is displayed to toggle between the display of the totalizers for both flow directions.
- Select the command `→Clear totalizer` in the upper line to reset the flow totalizers to zero.
- Press ENTER.

Automatic display toggling

The automatic toggling of the totalizer display between positive and negative flow direction can be set.

```
Special Funct.\SYSTEM settings\Measuring\Toggle totalizer
```

- Enter a time interval between 0 (off) and 5 s.
- Press ENTER.

Totalizer storing

It is possible to store the currently displayed totalizer only or to store one value for each flow direction.

```
Special Funct.\SYSTEM settings\Storing\Quantity Storage
```

- Select the menu item `Special Funct.\SYSTEM settings\Storing\Quantity Storage`.
- Press ENTER.
- If `one` is selected, only the value of the totalizer currently displayed will be stored. This can apply for the positive and negative totalizer.
- If `both` is selected, the values of the totalizers for both flow directions will be stored.
- Press ENTER.

Totalizer behavior after the measurement is stopped

The totalizer behavior when the measurement is stopped or after a reset of the transmitter is set in the menu item `Special Funct.\SYSTEM settings\Measuring\Quantity recall`.

```
Special Funct.\SYSTEM settings\Measuring\Quantity recall
```

- If `on` is selected, the values of the flow totalizers will be stored and used for the next measurement.
- If `off` is selected, the flow totalizers will be reset to zero.
- Press ENTER.

Totalizer overflow

The overflow behavior of the totalizers can be set:

```
Special Funct.\SYSTEM settings\Measuring\Quant. wrapping
```

- Select the menu item `Special Funct.\SYSTEM settings\Measuring\Quant. wrapping`.
- Select `on` to work with overflow.

The flow totalizer will be reset to zero automatically when ± 9999999999 is reached.

- Select `off` to work without overflow.

The value of the totalizer increases to the internal limit of 10^{38} . The values will be displayed as exponential numbers ($\pm 1.00000E10$), if necessary. The flow totalizer can only be reset to zero manually.

- Press ENTER.

Independent of the setting, the flow totalizers can be reset to zero manually.

Notice!

The overflow of a totalizer influences all output channels, e.g., data logger, online transmission of data.
The output sum of both totalizers (throughput ΣQ) transmitted via an output is not valid after the first overflow (wrapping) of one of the totalizers.
In order to signalize the overflow of a totalizer, an alarm output with the switching condition `QUANT.` and the type `HOLD` has to be activated.

16.2 NoiseTrek parallel beam mode (option)

The NoiseTrek parallel beam mode works with parallel mounted transducers. It improves the signal quality when measuring on small pipes or with strongly attenuating fluids.

```
Special Funct.\SYSTEM settings\Measuring\Enable NoiseTrek
```

- Select the menu item `Special Funct.\SYSTEM settings\Measuring`.
- Press ENTER until the menu item `Enable NoiseTrek` is displayed.
- Select `on` to enable the NoiseTrek parallel beam mode, `off` to disable it.
- Press ENTER.

16.3 Upper limit of the flow velocity

Single outliers caused by heavily disturbed surroundings can appear among the measured values of the flow velocity. If these outliers are not ignored, they will affect all derived physical quantities, which will be unsuitable for the integration (e.g., pulse outputs).

It is possible to ignore all measured flow velocities exceeding the preset upper limit. These measured values will be marked as outliers.

The upper limit of the flow velocity is set in the menu item `Special Funct.\SYSTEM settings\Measuring\Velocity limit`.

```
Special Funct.\SYSTEM settings\Measuring\Velocity limit
```

- Enter zero to switch off the outliers check.
- Enter a limit > 0 to switch on the outliers check. The measured flow velocity will then be compared to the entered upper limit.
- Press ENTER.

If the flow velocity is higher than the upper limit,

- the flow velocity will be marked as invalid. The physical quantity cannot be determined.
- a (!) will be displayed after the unit of measurement (in case of a normal error (?) is displayed).

Notice!

If the upper limit is too low, a measurement might be impossible because most of the measured values will be marked as invalid.

16.4 Cut-off flow

The cut-off flow is a lower limit for the flow velocity. All measured flow velocities that are lower than the limit and their derived quantities are set to zero.

The cut-off flow can depend on the flow direction. The cut-off flow is set in `Special Funct.\SYSTEM settings\Measuring\Cut-off Flow`.

```
Special Funct.\SYSTEM settings\Measuring\Cut-off Flow
```

- Select `sign` to define a cut-off flow depending on the flow direction. One limit is set for the positive and negative flow velocity.
- Select `absolut` to define a cut-off flow independent of the flow direction. A limit is set for the absolute value of the flow velocity.
- Press ENTER.
- Select `factory` to use the default limit of 2.5 cm/s (0.025 m/s) for the cut-off flow.
- Select `user` to enter the cut-off flow.
- Press ENTER.

If `Cut-off Flow\sign` and `user` are selected, 2 values have to be entered:

```
Special Funct.\...\+Cut-off Flow
```

- Enter the cut-off flow.
- Press ENTER.

All positive values of the flow velocity smaller than this limit are set to zero.

```
Special Funct.\...\-Cut-off Flow
```

- Enter the cut-off flow.
- Press ENTER.

All negative values of the flow velocity greater than this limit will be set to zero.

If `Cut-off Flow\absolut` and `user` are selected, only one value have to be entered:

```
Special Funct.\...\Cut-off Flow
```

- Enter the cut-off flow.
- Press ENTER.

All absolute values of the flow velocity smaller than this limit are set to zero.

16.5 Profile correction

The following settings can be made for the calculation of the fluid mechanics calibration factor k_{Re} :

- off: profile correction 1.0
- on: profile correction 2.0 at ideal inflow conditions (default)
- With disturbance: profile correction 2.0 at non ideal inflow conditions

The following steps are necessary to set the profile correction:

- Selection of the profile correction setting for all measuring channels in the program branch `Special Funct.`
- Input of the disturbance distance in the program branch `Parameter` if `With disturbance` has been selected

If `With disturbance` has been selected, the transducers have to be mounted in reflection arrangement, X arrangement or displaced X arrangement to compensate transverse flow effects. When mounting in X arrangement, it is essential to set the same parameters for both measuring channels and to activate for them a calculation channel with average generation.

Selection of the setting

```
Special Funct.\...\Measuring\ProfileCorr 2.0
```

- Select the menu item `Special Funct.` in the program branch `Measuring`.
- Press ENTER until the menu item `ProfileCorr 2.0` is displayed.
- Select a list item (default: `on`).
- Press ENTER.

Input of the disturbance distance

If `With disturbance` is selected in the menu item `Special Funct.\SYSTEM settings\Measuring\ProfileCorr 2.0`, the disturbance distance has to be entered in the program branch `Parameter`.

```
Disturb.distance  
2.3 m
```

- Enter the disturbance distance.
- Press ENTER.

Measurement

When starting the measurement, it is checked whether the measurement arrangement is appropriate.

16.6 Uncorrected flow velocity

For special applications, the uncorrected flow velocity might be of interest.

The profile correction for the flow velocity is activated in the menu item `Special Funct.\SYSTEM settings\Measuring\Flow Velocity`.

```
Special Funct.\SYSTEM settings\Measuring\Flow Velocity
```

- Select `normal` to display and output the flow velocity with profile correction.
- Select `uncorr.` to display and output the flow velocity without profile correction.
- Press ENTER.

If `uncorr.` is selected, each time the program branch `Measuring` is selected it will be requested whether the profile correction is to be used or not.

```
PROFILE CORR.  
>NO< yes
```

If `no` is selected, the profile correction will be switched off. All physical quantities will be calculated with the uncorrected flow velocity.

During the measurement, the designation of the physical quantity is displayed in capital letters to indicate that the value is uncorrected.

```
FLOW VELOCITY
  2.60    m/s
```

- Press ENTER.

```
PROFILE CORR.
>no<      YES
```

If `yes` is selected, the uncorrected flow velocity will only be used if the flow velocity is selected as physical quantity in the program branch `Output Options`.

All other physical quantities (volumetric flow rate, mass flow rate, etc.) will be determined with the corrected flow velocity. During the measurement, the designation of the physical quantity "flow velocity" is displayed in capital letters to indicate that the value is uncorrected.

- Press ENTER.

In both cases, the corrected flow velocity can also be displayed.

```
Flow Velocity
*U    24    m/s
```

Press key  to scroll until the flow velocity is displayed. The uncorrected flow velocity is marked with an "U". Uncorrected flow velocities transmitted to a PC are marked with `uncorr`.

16.7 Diagnosis with the help of the snap function

By means of the snap function it is possible to store measuring parameters which are useful for the evaluation of measuring results or diagnosis purposes.

```
Special Funct.\SYSTEM settings\Signal snap
```

- Select the menu item `Special Funct.\SYSTEM settings\Signal snap`.
- Press ENTER.

Snap memory settings

```
Special Funct.\SYSTEM settings\Signal snap\DSP-SignalSnap
```

- Select `on` to activate the snap function and `off` to deactivate it.
- Press ENTER.

```
Special Funct.\...\DSP-SignalSnap\Install Snap
```

- Select `Install Snap`.
- Press ENTER.

```
Special Funct.\...\DSP-SignalSnap\Install Snap\Snap-Memory
```

- Enter the number of the snap memory storage space.
- Press ENTER.

```
Special Funct.\...\DSP-SignalSnap\AutoSnap
```

- Activate or deactivate the auto-snap function.
- Press ENTER.

```
Special Funct.\...\DSP-SignalSnap\Snap ringbuffer
```

- Activate or deactivate the snap ringbuffer.
- Press ENTER.

Delete snaps

```
Special Funct.\SYSTEM settings\Signal snap\DSP-SignalSnap\Clear Snaps
```

- Select Clear Snaps.
- Press ENTER.

Read snaps

```
Special Funct.\SYSTEM settings\Signal snap\DSP-SignalSnap\Snaps ->Rs232
```

- Select Snaps ->Rs232.
- Press ENTER.

Activation of the snap function

- In order to activate the snap function, press key  until DSPSNAP/VOLTAGE is displayed in the upper line.
- Press ENTER.

16.8 Modification of the limit for the inner pipe diameter

It is possible to modify the lower limit of the inner pipe diameter for a given transducer type.

- Enter the HotCode **071001**, see section 8.4.

| |
|----------------|
| DNmin Q-Sensor |
| 15 mm |

- Enter the lower limit of the inner pipe diameter of the displayed transducer type.
- Press ENTER to select the next transducer type.

Notice!

If a transducer is used below its recommended inner pipe diameter, a measurement might be impossible.

16.9 Activation of a binary output as alarm output

Notice!

The menu item Alarm Output will only be displayed in the program branch Output Options if a binary output has been installed, see section 13.1.

```
Output Options\...\Alarm Output
```

- Select the program branch Output Options.
- Press ENTER until Alarm Output is displayed. Select yes to activate the alarm output.
- Press ENTER.

A max. of 3 independently operating alarm outputs R1, R2, R3 can be configured per channel. The alarm outputs can be used to output information on the current measurement or to start and stop pumps, motors, etc.



16.9.1 Alarm properties

The switching condition, the holding behavior and the switching function of an alarm output can be defined.

```
R1=FUNC<typ mode
Function:    MAX
```

The following 3 scroll lists are displayed:

- `func`: switching condition
- `typ`: holding behavior
- `mode`: switching function

Press key  to select a scroll list in the upper line. Press key  to select a list item in the lower line.

- Press ENTER to store the settings.

Tab. 16.1: Alarm properties

| alarm property | setting | description |
|--|----------|--|
| <code>func</code> (switching condition) | MAX | The alarm will switch if the measured value exceeds the upper limit. |
| | MIN | The alarm will switch if the measured value falls below the lower limit. |
| | +→- -→+ | The alarm will switch if the flow direction changes (sign change of measured value). |
| | QUANT. | The alarm will switch if totalizing is activated and the totalizer reaches the limit. |
| | ERROR | The alarm will switch if a measurement is not possible. |
| | OFF | The alarm is switched off. |
| <code>typ</code> (holding behavior) | NON-HOLD | If the switching condition is no longer true, the alarm will return to the idle state after approx. 1 s. |
| | HOLD | The alarm remains activated even if the switching condition is no longer true. |
| <code>mode</code> (switching function) | NO Cont. | The alarm is energized if the switching condition is true and de-energized if idle. |
| | NC Cont. | The alarm is de-energized if the switching condition is true and energized if idle. |

Notice!

If no measurement is made, all alarms will be de-energized, independently of the programmed switching function.

16.9.2 Setting the limits

If the switching condition `MIN` or `MAX` is selected in the scroll list `func`, the limit of the output has to be defined:

```
R1 Input\Mass Flow
```

- Select the physical quantity to be used for the comparison in the scroll list `Input`. The following list items are available for the alarm output R1:
 - selected physical quantity
 - signal amplitude
 - sound speed of the fluid
- Press ENTER.

If the switching condition `MAX` is selected in the scroll list `func`:

```
R1 Input\Function: MAX\High Limit
```

- Enter the upper limit.
- Press ENTER.

The alarm will switch if the measured value exceeds the limit.

If the switching condition `MIN` is selected in the scroll list `func`:

```
R1 Input\Function: MIN\Low Limit
```

- Enter the lower limit.
- Press ENTER.

The alarm will switch if the measured value falls below the limit.

Example

```
High Limit: -10 kg/h
mass flow rate = -9.9 kg/h
the limit is exceeded, the alarm switches
mass flow rate = -11 kg/h
the limit is not exceeded, the alarm does not switch
```

Example

```
Low Limit: -10 kg/h
mass flow rate = -11 kg/h
the measured value is below the limit, the alarm switches
mass flow rate = -9.9 kg/h
the measured value is not below the limit, the alarm does not switch
```

If the switching condition `QUANT.` is selected in the scroll list `func`, the limit of the output has to be defined:

```
R1 Input\Function: QUANT.\Quantity Limit
```

- Enter the limit of the totalizer.
- Press ENTER.

The alarm will switch when the measured value reaches the limit.

A positive limit will be compared to the totalizer value for the positive flow direction.

A negative limit will be compared to the totalizer value for the negative flow direction.

The comparison will also take place if the totalizer of the other flow direction is displayed.

Notice!

The unit of measurement of the limit is set according to the unit of measurement of the selected physical quantity.
If the unit of measurement of the physical quantity is changed, the limit has to be converted and entered again.

Example

```
physical quantity: mass flow rate in kg/h
Quantity Limit: 1 kg
```

Example

physical quantity: mass flow rate in kg/h

Low Limit: 60 kg/h

The unit of measurement of the physical quantity is changed to kg/min. The new limit to be entered is 1 kg/min.

16.9.3 Defining the hysteresis

A hysteresis can be defined for the alarm output R1. This prevents a constant triggering of the alarm when measured values fluctuate marginally around the limit.

The hysteresis is a symmetrical range around the limit. The alarm will be activated if the measured values exceed the upper limit and deactivated if the measured values fall below the lower limit.

Example

High Limit: 30 kg/h

Hysteresis: 1 kg/h

The alarm is activated for measured values > 30.5 kg/h and deactivated for measured values < 29.5 kg/h.

If the switching condition `MAX` or `MIN` is selected in the scroll list `func`:

```
R1 Input\...\Hysteresis
```

- Enter a value for the hysteresis or enter zero to work without hysteresis.
- Press ENTER.

16.10 Behavior of the alarm outputs**16.10.1 Apparent switching delay**

The measured values and totalizer values will be displayed rounded to 2 decimal places. The limits, however, will be compared to the non-rounded measured values. This might cause an apparent switching delay when the measured value changes marginally (less than 2 decimal places). In this case the switching accuracy of the output is higher than the accuracy of the display.

16.10.2 Reset and initialization of the alarms

After an initialization of the transmitter, all alarm outputs will be configured as follows:

Tab. 16.2: Alarm state after an initialization

| | |
|-------|----------|
| func | OFF |
| typ | NON-HOLD |
| mode | NO Cont. |
| Limit | 0.00 |

Press 3 times key C during the measurement to set all alarm outputs to idle state. Alarm outputs whose switching condition is still met will be activated again after 1 s. This function is used to reset alarm outputs of the type `HOLD` if the switching condition is no longer met.

By pressing key BRK, the measurement is stopped and the main menu is selected. All alarm outputs will be de-energized, independently of the programmed idle state.

16.10.3 Alarm outputs during transducer positioning

At the beginning of the transducer positioning (bar graph display), all alarm outputs switch back to the programmed idle state.

If the bar graph is selected during the measurement, all alarm outputs will switch back to the programmed idle state.

An alarm output of the type `HOLD` that has been activated during the previous measurement will remain in idle state after the transducer positioning if its switching condition is no longer met.

The switching of the alarms into idle state will not be displayed.

16.10.4 Alarm outputs during measurement

An alarm output with switching condition `MAX` or `MIN` will be updated max. once per second to avoid humming (i.e. fluctuation of the measured values around the value of the switching condition).

An alarm output of the type `NON-HOLD` will be activated if the switching condition is met. It will be deactivated if the switching condition is no longer met. The alarm remains activated for at least 1 s even if the switching condition is met for a shorter period of time.

Alarm outputs with the switching condition `QUANT.` will be activated if the limit is reached.

Alarm outputs with the switching condition `ERROR` will only be activated after several unsuccessful measuring attempts. Therefore, typical short-term disturbances of the measurement (e.g., switching on of a pump) will not activate the alarm.

Alarm outputs with the switching condition `+<->->+` and the type `NON-HOLD` will be activated with each change of the flow direction for approx. 1 s, see Fig. 16.1.

Alarm outputs with the switching condition `+<->->+` and of the type `HOLD` will be activated after the first change of the flow direction. They can be switched back by pressing key C 3 times, see Fig. 16.1.

Fig. 16.1: Behavior of a relay when the flow direction changes

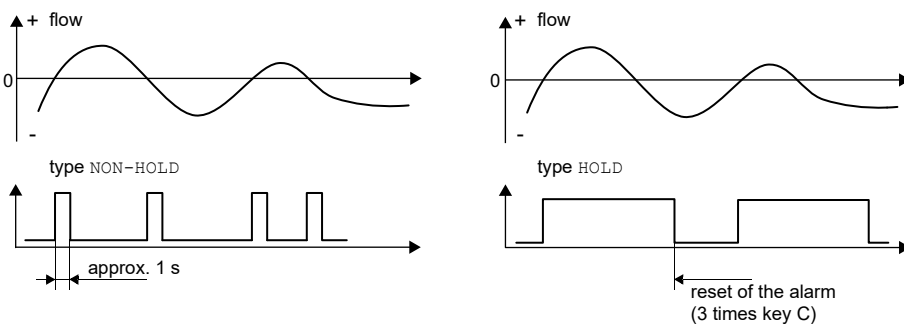

When adjusting to changed measurement conditions e.g. a substantial increase of the fluid temperature, the alarm will not be switched. Alarm outputs with the switching condition `OFF` will be set automatically to the switching function `NO Cont.`

Notice!

There is neither a visual nor an acoustic indication of the alarm output switching.

The alarm state can be displayed after the configuration of the alarm outputs and during the measurement. This function is activated in `Special Funct.\SYSTEM settings\Dialogs/Menus`. The activation of this function is recommended when alarm outputs have to be reconfigured frequently.

```
Special Funct.\SYSTEM settings\Dialogs/Menus\SHOW RELAIS STAT
```

- Select the menu item `SHOW RELAIS STAT`.
- Select `on` to activate the alarm state indication.
- Press `ENTER`.

If the alarm state indication is activated, the alarm output state is displayed after configuring the alarm outputs.

The alarm state indication is structured as follows:

Rx = , with X being the number of the alarm output and a pictogram according to Tab. 16.3.

The configuration of the alarm outputs can be repeated by pressing key C. When the configuration of the alarm outputs is finished, press `ENTER`. The main menu will be displayed.

If the alarm output indication is activated, the alarm state can be displayed during the measurement. Press key to scroll through the upper line or key in the lower line until the alarm state is displayed.

Tab. 16.3: Pictograms for the alarm state indication

| | no. | | func (switching condition) | typ (holding behavior) | mode (switching function) | current state |
|---|----------------------|---|-------------------------------|---------------------------|------------------------------|----------------------|
| R | <input type="text"/> | = | <input type="text"/> | <input type="text"/> | <input type="text"/> | <input type="text"/> |
| | | | OFF | NON-HOLD | NO Cont. | closed |
| | 1 | | MAX | HOLD | NC Cont. | open |
| | 2 | | MIN | | | |
| | 3 | | +→ -→+ | | | |
| | | | QUANT. | | | |
| | | | ERROR | | | |

Example

R1 =

16.10.5 Deactivation of an alarm output

If the programmed outputs are no longer required, they can be deactivated. The configuration of a deactivated output is stored and will be available if the output is activated again.

Output Options\...\Alarm Output

- Select no in Output Options\Alarm Output to deactivate an output.
- Press ENTER.

17 SuperUser mode

The SuperUser mode offers the possibility of an advanced diagnostic of signals and measured values as well as the definition of additional parameters adapted to the measuring point, in order to achieve better measured values or for experimental work. Special features of the SuperUser mode are:

- Default settings will not be used.
- There are no plausibility tests during the parameter entry.
- It is not checked whether the entered parameters are within the limits given by physical laws and technical data.
- The cut-off flow is not activated.
- A number of sound paths has to be entered.

Some menu items that are not visible in the normal mode are displayed.

Notice!

The SuperUser mode is intended for experienced users with advanced application knowledge. The parameters can affect the normal measuring mode and lead to wrong measured values or to a measurement failure when a new measuring point is set up.

17.1 Activation/deactivation

- Enter the HotCode **071049**, see section 8.4.
- Press ENTER.

```
SUPERUSER MODE\IS ACTIVE NOW
```

It is displayed that the SuperUser mode is activated.

- Press ENTER. The main menu will be displayed.
- Enter the HotCode **071049** again to deactivate the SuperUser mode.

```
SUPERUSER MODE\IS PASSIVE NOW
```

It is displayed that the SuperUser mode is deactivated.

- Press ENTER. The main menu will be displayed.

Notice!

Some of the defined parameters are still activated after the deactivation of the SuperUser mode.

17.2 Defining flow parameters

In the SuperUser mode, it is possible to define some flow parameters (profile bounds, correction of the flow velocity) for the specific application or measuring point.

```
Special Funct.\SYSTEM settings\Measuring\Calibration
```

- Select the menu item `Special Funct.\SYSTEM settings\Measuring\Calibration`.
- Press ENTER.

17.2.1 Profile bounds

```
Special Funct.\...\Calibration\...\Profile bounds
```

- Select `user` to define the profile bounds. If `factory` is selected, the default profile bounds will be used and the menu item `Calibration` will be displayed.
- Press ENTER.

```
Special Funct.\...\Calibration\...\Laminar flow
```

- Enter the max. Reynolds number at which the flow is laminar. The entered number will be rounded to hundreds. Enter zero to use the default value of 1000.
- Press ENTER.

```
Special Funct.\...\Calibration\...\Turbulent flow
```

- Enter the min. Reynolds number at which the flow is turbulent. The entered number will be rounded to hundreds. Enter zero to use the default value of 3000.
- Press ENTER.

```
Special Funct.\...\Calibration\...\Calibration
```

A request is displayed if an additional correction of the flow velocity is to be defined.

- Select *on* to define the correction data, *off* to work without correction of the flow velocity and return to the menu item `SYSTEM` settings.

Example

profile bound for laminar flow: 1500

profile bound for turbulent flow: 2500

At Reynolds numbers < 1500, the flow is regarded as laminar for the calculation of the physical quantity. At Reynolds numbers > 2500, the flow is regarded as turbulent. The range 1500...2500 is the transition range between laminar and turbulent flow.

Notice!

The defined profile bounds are still activated after the deactivation of the SuperUser mode.

17.2.2 Correction of the flow velocity

After the profile bounds have been defined, it is possible to define a correction of the flow velocity:

$$v_{\text{cor}} = m \cdot v + n$$

where

- v – measured flow velocity
- m – slope, range: -2.0...+2.0
- n – offset, range: -12.7...+12.7 cm/s
- v_{cor} – corrected flow velocity

All quantities derived from the flow velocity will be calculated with the corrected flow velocity. The correction data will be transmitted to the PC or printer during the online or offline transmission.

Notice!

It will not be displayed that the correction of the flow velocity is active during the measurement.

```
Special Funct.\...\Calibration\...\Calibration
```

- Select *on* to define the correction data, *off* to work without correction of the flow velocity and return to the menu item `SYSTEM` settings.

```
Special Funct.\...\Calibration\...\Calibration\Slope
```

- If on is selected, enter the slope. The input of zero deactivates the correction.
- Press ENTER.

```
Special Funct.\...\Calibration\...\Calibration\Offset
```

- Enter the offset. Enter zero to work without offset.
- Press ENTER.

Example

Slope: 1.1

Offset: -10.0 cm/s = -0.1 m/s

If a flow velocity $v = 5$ m/s is measured, before the calculation of the derived quantities, it will be corrected as follows:

$$v_{\text{cor}} = 1.1 \cdot 5 \text{ m/s} - 0.1 \text{ m/s} = 5.4 \text{ m/s}$$

Example

Slope: -1.0

Offset: 0.0

Only the sign of the measured values changes.

Notice!

The correction data will only be stored when a measurement is started. If the transmitter is switched off without starting a measurement, the entered correction data will be lost.

Notice!

The correction of the flow velocity is still activated after the deactivation of the SuperUser mode.

17.3 Limit of the signal amplification

In order to prevent disturbing and/or pipe wall signals (e.g., if the pipe has run empty) from being interpreted as useful signals, it is possible to define a max. signal amplification. If the signal amplification is greater than the max. signal amplification,

- the flow velocity will be marked as invalid. The physical quantity cannot be determined.
- a hash symbol (#) will be displayed after the unit of measurement (in case of a normal error, (?) is displayed).

```
Special Funct.\SYSTEM settings\Measuring\Miscellaneous\Gain threshold
```

- Select the menu item Special Funct.\SYSTEM settings\Measuring\Miscellaneous.
- Press ENTER until the menu item Gain threshold is displayed.

```
Special Funct.\SYSTEM settings\Measuring\Miscellaneous\Gain threshold\Fail if > 90 dB
```

- Enter for each measuring channel the max. signal amplification.
- Enter zero to measure without a limit of the signal amplification.
- Press ENTER.

The current value of the amplification (GAIN) can be displayed in the upper line in the program branch Measuring. If the current value of the amplification is higher than the max. amplification, the current value is displayed with →FAIL!.

Notice!

The limit of the signal amplification is still activated after the deactivation of the SuperUser mode.

17.4 Upper limit of the sound speed

When the plausibility of the signal is evaluated, it will be checked whether the sound speed is within a defined range. The used upper limit of the fluid sound speed is the greatest of the following values:

- fixed upper value, default: 1848 m/s
- value of the sound speed curve of the fluid at the operating point plus offset, default offset: 300 m/s

In the SuperUser mode, the values can be defined for fluids that are not contained in the data set of the transmitter.

```
Special Funct.\SYSTEM settings\Measuring\Miscellaneous\Bad soundspeed
```

- Select the menu item `Special Funct.\SYSTEM settings\Measuring\Miscellaneous`.
- Press ENTER until the menu item `Bad soundspeed` is displayed.

```
Special Funct.\SYSTEM settings\Measuring\Miscellaneous\Bad soundspeed\thresh.
```

- Enter for each measuring channel the fixed upper limit of the sound speed.
- Enter zero to use the default value of 1848 m/s.
- Press ENTER.

```
Special Funct.\SYSTEM settings\Measuring\Miscellaneous\Bad soundspeed\offset
```

- Enter for each measuring channel the offset.
- Enter zero to use the default value of 300 m/s.
- Press ENTER.

Example

fixed upper value of the sound speed (`thresh.`): 2007 m/s
offset: 600 m/s
value of the sound speed curve at the operating point: 1546 m/s

As $1546 \text{ m/s} + 600 \text{ m/s} = 2146 \text{ m/s}$ is greater than the fixed upper value 2007, this value will be used as the upper limit of the sound speed when the plausibility of the signal is evaluated.

It is possible to display the valid range for the sound speed (`SS`) in the lower line within the program branch `Measuring` during the measurement. The second value (here: 2146 m/s) corresponds to the upper limit at the operating point.

Fig. 17.1: Display of the valid sound speed range

```
GAIN=91dB
SS=1038/2146 m/s
```

Notice!

The defined upper limit of the sound speed remains activated after the deactivation of the SuperUser mode.

17.5 Detection of long measurement failures

If there are no valid measured values during a long time interval, new increments of the totalizers will be ignored. The values of the totalizers remain unchanged.

In the SuperUser mode, it is possible to set the time interval.

```
Special Funct.\SYSTEM settings\Measuring\Miscellaneous\Do not total. if no meas.
```

- Select the menu item `Special Funct.\SYSTEM settings\Measuring\Miscellaneous`.
- Press ENTER until the menu item `Do not total. if no meas.` is displayed.
- Enter the time. If zero is entered, the default value of 30 s will be used.
- Press ENTER.

17.6 Number of decimal places of the totalizers

The totalizer values can be displayed with up to 11 places, e.g., 74890046.03. In the SuperUser mode, it is possible to define the number of decimal places.

```
Special Funct.\SYSTEM settings\Measuring\Miscellaneous\Total digits
```

- Select the menu item `Special Funct.\SYSTEM settings\Measuring\Miscellaneous`.
- Press ENTER until the menu item `Total digits` is displayed.
- Select one of the following list items:
 - Automatic: dynamic adaptation
 - Fixed to x digit: x decimal places (range: 0..4)
- Press ENTER.

Total digits = Automatic

The number of decimal places will be adjusted dynamically. Low totalizer values will initially be displayed with 3 decimal places. If the values of the totalizers are higher, the number of decimal places will be reduced.

| max. value | display |
|-------------|-----------------------------|
| $< 10^6$ | ±0.000 ... ±999999.999 |
| $< 10^7$ | ±1000000.00 ... ±9999999.99 |
| $< 10^8$ | ±10000000.0 ... ±99999999.9 |
| $< 10^{10}$ | ±1000000000 ... ±9999999999 |

Total digits = Fixed to x digit

The number of decimal points is constant. The max value of the totalizer is reduced with the number of decimal places.

| decimal places | max. value | max. display |
|----------------|-------------|--------------|
| 0 | $< 10^{10}$ | ±9999999999 |
| 1 | $< 10^8$ | ±99999999.9 |
| 2 | $< 10^7$ | ±9999999.99 |
| 3 | $< 10^6$ | ±999999.999 |
| 4 | $< 10^5$ | ±99999.9999 |

Notice!

The number of decimal places and the max. value defined here only affect the display of the totalizers.

17.7 Manual reset of the totalizers

If the manual reset of the totalizers is activated, the totalizers can be reset to zero during the measurement by pressing key C 3 times, even if a program code is activated.

```
Special Funct.\SYSTEM settings\Measuring\Miscellaneous\3xC clear totals
```

- Select the menu item `Special Funct.\SYSTEM settings\Measuring\Miscellaneous`.
- Press ENTER until the menu item `3xC clear totals` is displayed.
- Select `on` to activate the manual reset of the totalizers, `off` to deactivate it.
- Press ENTER.

Notice!

The manual reset of the totalizers is still activated after the deactivation of the SuperUser mode.

17.8 Display of the totalizer sum

The totalizer sum of both flow directions can be displayed in the upper line during the measurement.

```
Special Funct.\SYSTEM settings\Measuring\Miscellaneous\Show ΣQ
```

- Select the menu item `Special Funct.\SYSTEM settings\Measuring\Miscellaneous`.
- Press ENTER until the menu item `Show ΣQ` is displayed.
- Select `on` to activate the display of the totalizer sum, `off` to deactivate it.
- Press ENTER.

If the display of the totalizer sum is activated, the sum ΣQ of the totalizers can be displayed in the upper line during the measurement.

Fig. 17.2: Display of the totalizer sum

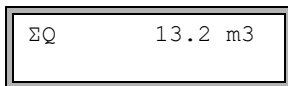

17.9 Display of the last valid measured value

If the signal is not sufficient for a measurement, UNDEF is normally displayed. Instead of UNDEF, it is also possible to display the last valid measured value.

```
Special Funct.\SYSTEM settings\Measuring\Miscellaneous\Keep display val
```

- Select the menu item `Special Funct.\SYSTEM settings\Measuring\Miscellaneous`.
- Press ENTER until the menu item `Keep display val` is displayed.
- Select `on` to activate the display of the last valid measured value, `off` to deactivate it.
- Press ENTER.

17.10 Displays during the measurement

Besides the normal information, see section 9.4, the following parameters can be displayed during the measurement in the SuperUser mode:

| display | explanation |
|---------|--|
| t | transit time of the measuring signal in the fluid |
| c | sound speed |
| REYNOLD | Reynolds number |
| VARI A | standard deviation of the signal amplitude |
| VARI T | standard deviation of the transit time of the measuring signal |
| dt-norm | transit time difference standardized to the transducer frequency |
| | fluid density |

18 Settings

18.1 Dialogs and menus

```
Special Funct.\SYSTEM settings\Dialogs/Menu
```

- Select the menu item `Special Funct.\SYSTEM settings\Dialogs/Menu`.
- Press ENTER.

Notice!

The settings will be stored at the end of the dialog. If the menu item is quit by pressing key BRK, the changes will not be stored.

18.1.1 Pipe circumference

```
Special Funct.\...\Dialogs/Menu\Pipe Circumfer.
```

- Select on if the pipe circumference is to be entered instead of the pipe diameter in the program branch `Parameter`.
- Press ENTER.

```
Special Funct.\...\Dialogs/Menu\Pipe Circumfer.\Outer Diameter
```

If on is selected for `Pipe Circumfer.`, the outer pipe diameter will still be requested in the program branch `Parameter`.

- In order to select the menu item `Pipe Circumfer.`, enter zero.
- Press ENTER.

The value displayed in `Pipe Circumfer.` is calculated on the basis of the last displayed value of the outer pipe diameter.
Example: 100 mm · π = 314.2 mm

- Enter the pipe circumference. The limits for the pipe circumference are calculated on the basis of the limits for the outer pipe diameter.
- Press ENTER.

During the next scroll through the program branch `Parameter`, the outer pipe diameter that corresponds to the entered pipe circumference will be displayed.

Example: 180 mm : π = 57.3 mm

Notice!

The edition of the pipe circumference is only temporarily. When the transmitter switches back to the display of the pipe circumference (internal recalculation), slight rounding errors may occur.

Example

entered pipe circumference: 100 mm

displayed outer pipe diameter: 31.8 mm

When the transmitter switches back to the display of the pipe circumference, 99.9 mm will be displayed.

18.1.2 Measuring point number

```
Special Funct.\...\Dialogs/Menu\Meas.Point No.:
```

- Select (1234) if the measuring point is to be identified only by numbers, point and hyphen.
- Select (↑↓← →) if the measuring point is to be designated with ASCII characters.
- Press ENTER.

18.1.3 Transducer distance

```
Special Funct.\...\Dialogs/Menus\Transd. Distance
```

recommended setting: user

- user will be selected if the measuring point is always the same
- auto can be selected if the measuring point often changes

In the program branch `Measuring`, the recommended transducer distance will be displayed in parentheses, followed by the entered transducer distance if the recommended and the entered transducer distance are not identical.

```
Transd. Distance  
(50.8) 50.0 mm
```

During the transducer positioning, in the program branch `Measuring`:

- only the entered transducer distance will be displayed if `Transd. Distance = user` is selected and the recommended and the entered transducer distances are identical
- only the recommended transducer distance will be displayed if `Transd. Distance = auto` is selected

18.1.4 Error delay

The error delay is the time interval after which the entered value for the error value is transmitted to the output in case no valid measured values are available.

```
Special Funct.\...\Dialogs/Menus/Error-val. delay
```

- Select `damping` if the damping factor is to be used as the error delay. Select `edit` to activate the menu item `Error-val. delay` in the program branch `Output Options`. From now on, the error delay can be entered in the program branch `Output Options`.
- Press ENTER.

18.1.5 Alarm state indication

```
Special Funct.\...\Dialogs/Menus\SHOW RELAIS STAT
```

- Select `on` to display the alarm state during the measurement.
- Press ENTER.

18.1.6 Units of measurement

It is possible to set the units of measurement for the length, temperature, pressure, density and kinematic viscosity and sound speed.

- Select a unit of measurement for all quantities.
- Press ENTER after each selection.

18.1.7 Settings relating the fluid pressure

It is possible to set whether the absolute or the relative pressure is to be used:

```
Special Funct.\...\Dialogs/Menus\Pressure absolut
```

- Select `on` or `off`.
- Press ENTER.

If `on` is selected, the absolute pressure p_a will be displayed/input/transmitted.

If `off` is selected, the relative pressure p_g will be displayed/input/transmitted.

$$p_g = p_a - 1.01 \text{ bar}$$

The pressure and its unit of measurement will, e.g., be displayed in the program branch `Parameter`. It is followed by the selected pressure, indicated in parentheses:

a – absolute pressure
g – relative pressure

| |
|-------------------------------|
| Fluid pressure 1.00 bar(a) |
|-------------------------------|

18.2 Measurement settings

```
Special Funct.\SYSTEM settings\Measuring
```

- Select the menu item `Special Funct.\SYSTEM settings\Measuring`.
- Press ENTER.

Notice!

The settings will be stored at the end of the dialog. If the menu item is quit by pressing key BRK, the changes will not be stored.

```
Special Funct.\...\Measuring\Compare c-fluid
```

- Select `yes` if the measured sound speed is to be compared to the theoretical or expected value.
- Press ENTER.

The difference $\delta c = c_{\text{mea}} - c_{\text{stored}}$ between the two sound speeds will be displayed in the lower line during the measurement. c_{stored} is the sound speed of the reference fluid stored in the database.

- Press key  during the measurement to scroll to the display of δc .

```
Special Funct.\...\Measuring\ProfileCorr 2.0
```

- Select a list item:
 - `off`: profile correction 1.0
 - `on`: profile correction 2.0 at ideal inflow conditions (default)
 - `With disturbance`: profile correction 2.0 at non ideal inflow conditions
- Press ENTER.

```
Special Funct.\...\Measuring\Flow Velocity
```

- Select `normal` to display and transmit the profile corrected flow values, `uncorr.` to display and output the flow values without flow profile correction.
- Press ENTER.

For further information, see section 16.3.

Special Funct.\...\Measuring\Velocity limit

An upper limit for the flow velocity can be entered, see section 16.3.

- Enter zero to deactivate the flow velocity check.
- Press ENTER.

Special Funct.\...\Measuring\Cut-off Flow

A lower limit for the flow velocity can be entered.

- Select `sign` to define a cut-off flow depending on the flow direction. One limit is set for the positive and negative flow velocity.
- Select `absolut` to define a cut-off flow independent of the flow direction. A limit is set for the absolute value of the flow velocity.
- Press ENTER.
- Select `factory` to use the default limit of 2.5 cm/s (0.025 m/s) for the cut-off flow.
- Select `user` to enter the cut-off flow.
- Press ENTER.

If `Cut-off Flow\sign` and `user` are selected, 2 values have to be entered:

Special Funct.\...\Measuring\Cut-off Flow\+Cut-off Flow

- Enter the cut-off flow.
- Press ENTER.

All positive values of the flow velocity smaller than this limit are set to zero.

Special Funct.\...\Measuring\Cut-off Flow\ -Cut-off Flow

- Enter the cut-off flow.
- Press ENTER.

All negative values of the flow velocity greater than this limit will be set to zero.

If `Cut-off Flow\absolut` and `user` are selected, only one value have to be entered:

Special Funct.\...\Measuring\Cut-off Flow

- Enter the cut-off flow.
- Press ENTER.

The absolute value of all flow velocity values lower than this limit will be set to zero.

Special Funct.\...\Measuring\Quant. wrapping

- Select the overflow behavior of the totalizers, see section 16.1.
- Press ENTER.

Special Funct.\...\Measuring\Quantity recall

- Select `on` to keep the previous totalizer values after a restart of the measurement.
- Select `off` to reset the totalizers to zero after a restart of the measurement.
- Press ENTER.

```
Special Funct.\...\Measuring\Toggle totalizer
```

It is possible to set a time period after which the display toggles between the positive and the negative totalizer during the measurement.

- Enter a time interval between 0 (off) and 5 s.
- Press ENTER.

18.3 Libraries

The internal material database of the transmitter contains parameters for pipe and lining materials as well as for fluids.

The material and fluid scroll list displayed in the program branch `Parameter` can be arranged. Shorter scroll lists make work more effective.

```
Special Funct.\SYSTEM settings\Libraries
```

- Select the menu item `Special Funct.\SYSTEM settings\Libraries`.
- Press ENTER.

```
Special Funct.\SYSTEM settings\Libraries\Material list
```

- Select `Material list` to edit the material scroll list or `Medium list` to edit the fluid scroll list.
- Select `go back` to return to the menu item `SYSTEM settings`.
- Press ENTER.
- Select `factory` if all materials/fluids of the internal database are to be displayed in the scroll list. An already existing scroll list will not be deleted but only deactivated.
- Select `user` to activate the user defined scroll list.
- Press ENTER.

```
Special Funct.\...\Material list\user\Show list
```

If `user` is selected, the material or fluid scroll list can be edited, see section 18.3.1...18.3.3.

```
Special Funct.\...\Material list\user\End of Edit
```

- Select `End of Edit` to stop editing.
- Press ENTER.

```
Special Funct.\...\Material list\user\Save List?
```

- Select `yes` to store all changes of the scroll list or `no` to quit the menu item without storing.
- Press ENTER.

Notice!

If the material/fluid scroll list is quit by pressing key BRK before storing, all changes will be lost.

18.3.1 Displaying a scroll list

```
Special Funct.\...\Material list\user\Show list
```

- Select Show list.
- Press ENTER to display the scroll list as in the program branch Parameter.

```
Special Funct.\...\Material list\user\Show list\Current list= ↑
```

The current scroll list is displayed in the lower line.

- Press ENTER to return to the scroll list Material list or Medium list.

18.3.2 Adding a material/fluid to the scroll list

```
Special Funct.\...\Material list\user\Add Material
```

- Select Add Material or Add Medium to add a material/fluid to the scroll list.
- Press ENTER.

All materials/fluids that are not contained in the current scroll list will be displayed in the lower line.

```
>Add Material ↑  
Stainless Steel
```

- Select the material/fluid.
- Press ENTER. The material/fluid is added to the scroll list.

Notice!

The materials/fluids are displayed in the order in which they have been added.

18.3.3 Adding all materials/fluids to the scroll list

```
Special Funct.\...\Material list\user\Add all
```

- Select Add all to add all materials/fluids of the database to the current scroll list.
- Press ENTER.

18.3.4 Removing a material/fluid from the scroll list

```
Special Funct.\...\Material list\user\Remove Material
```

- Select Remove Material or Remove Medium to remove a material/fluid from the scroll list.
- Press ENTER.

All materials/fluids of the current scroll list will be displayed in the lower line.

```
>Remove Material↑  
Stainless Steel
```

- Select the material/fluid.
- Press ENTER. The material/fluid will be removed from the scroll list.

Notice!

User defined materials/fluids will always be displayed in the scroll lists of the program branch Parameter. They cannot be removed.

18.3.5 Removing all materials/fluids from the scroll list

```
Special Funct.\...\Material list\user\Remove all
```

- Select `Remove all` to remove all materials/fluids from the scroll list.
- Press ENTER. User defined materials/fluids will not be removed.

18.4 Contrast settings

```
Special Funct.\SYSTEM settings\Miscellaneous
```

- Select the menu item `Special Funct.\SYSTEM settings\Miscellaneous`.
- Press ENTER.

```
Special Funct.\SYSTEM settings\Miscellaneous\SETUP DISPLAY
```

- Select the menu item `Special Funct.\SYSTEM settings\Miscellaneous` to set the display contrast of the transmitter. The display contrast is adjusted with the following keys:

- increases the contrast
- ↓ reduces the contrast

- Press ENTER.

It is possible to reset the display to medium contrast by means of a HotCode.

- Enter the HotCode **555000**, see section 8.4.

Notice!

After an initialization of the transmitter, the display is reset to medium contrast.

18.5 Program code

A running measurement can be protected against inadvertent intervention by a program code.

If a program code has been defined, it will be requested in case of any intervention in the measurement (a command or key BRK).

18.5.1 Defining a program code

```
Special Funct.\Program code
```

- Select the menu item `Special Funct.\Program code`.
- Press ENTER.
- Enter a program code with max. 6 digits.
- Press ENTER.

An error message will be displayed if a reserved number has been entered (e.g., a HotCode for language selection).

```
INVALID CODE !
909049
```

A program code will remain valid as long as:

- no other valid program code is entered or
- the program code is not deactivated

Notice!

Do not forget the program code!



18.5.2 Intervention in the measurement

If a program code is activated, the message PROGRAM CODE ACTIVE will be displayed for a few seconds when a key is pressed.

If key BRK is pressed:

In order to stop a running measurement, the complete program code has to be entered (= Break Code).

```
INPUT BREAK_CODE  
CODE: 000000
```

- Enter the program code with the keys  and .
- Press ENTER.

If the entered program code is invalid, an error message will be displayed for a few seconds.



```
INPUT BREAK_CODE  
INVALID CODE !
```

If the entered program code is valid, the measurement will be stopped.

If a command is selected:

In order to execute a command, it is sufficient to enter the first 3 digits of the program code (= Access Code).

```
INP. ACCESS CODE  
CODE: 000000
```

- Enter the first 3 digits of the program code with the keys  and .
- Press ENTER.

At first, 000000 is displayed. If the program code starts with 000, ENTER can be pressed immediately.

18.5.3 Deactivation of the program code

```
Special Funct.\Program code
```

- Select Special Funct.\Program code.
- Press ENTER.
- Enter "-----" to delete the program code.
- Press ENTER.

If the character "-" is entered less than 6 times, this character sequence will be used as the new program code.

Annex

A Menu structure

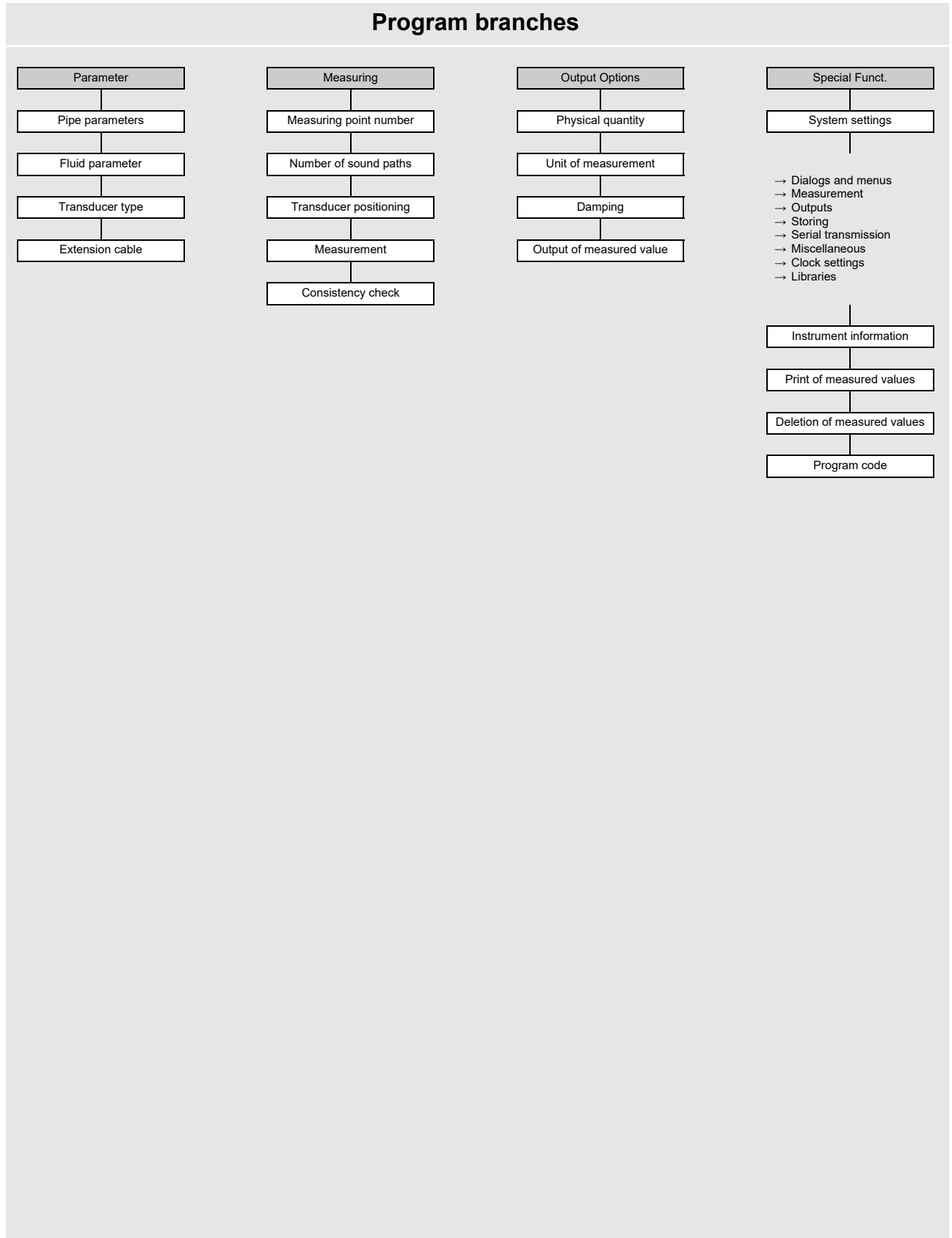

Parameter input

(see chapter 9)

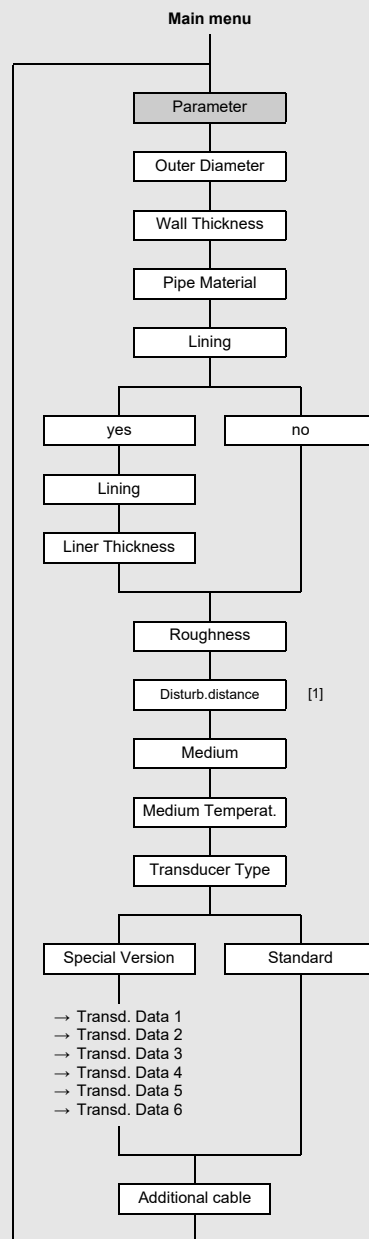

Legend

[1] only if with disturbance is selected in the menu item Special Funct.\SYSTEM settings\
Measuring\ProfileCorr 2.0

Measurement settings

(see chapter 9)

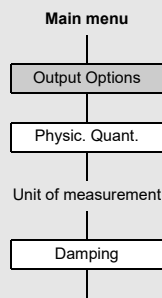

Data logger

(see chapter 14)

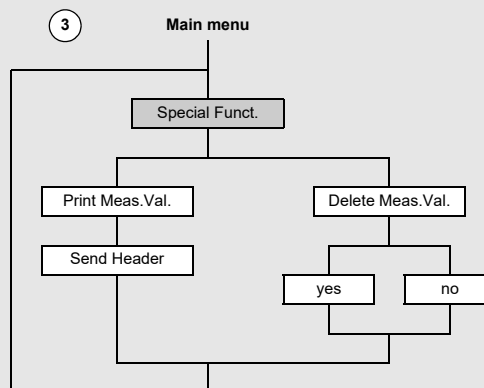
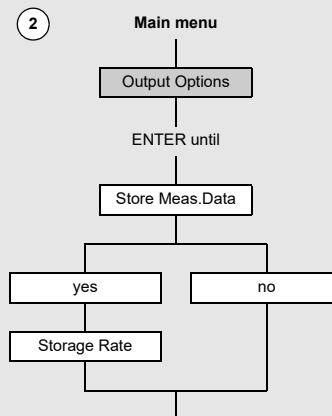
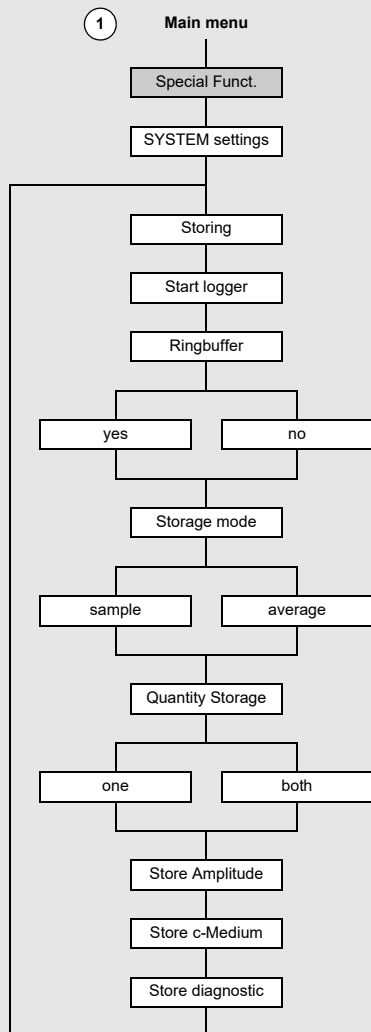

Measurement start

(see chapter 9)

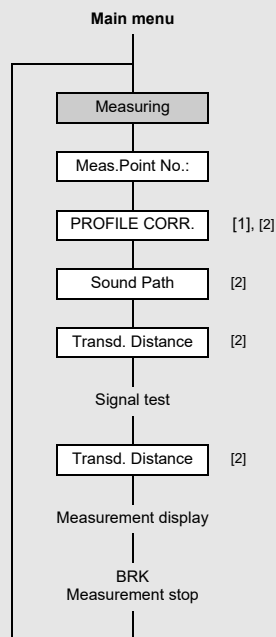

Legend

- [1] this will only be displayed if uncorr. is selected in the menu item Special Funct.\SYSTEM settings\Measuring\Flow Velocity
- [2] this will only be displayed if Enable NoiseTrek has not been activated in the menu item Special Funct.\SYSTEM settings\Measuring

Configuration of the outputs

(see chapter 9)

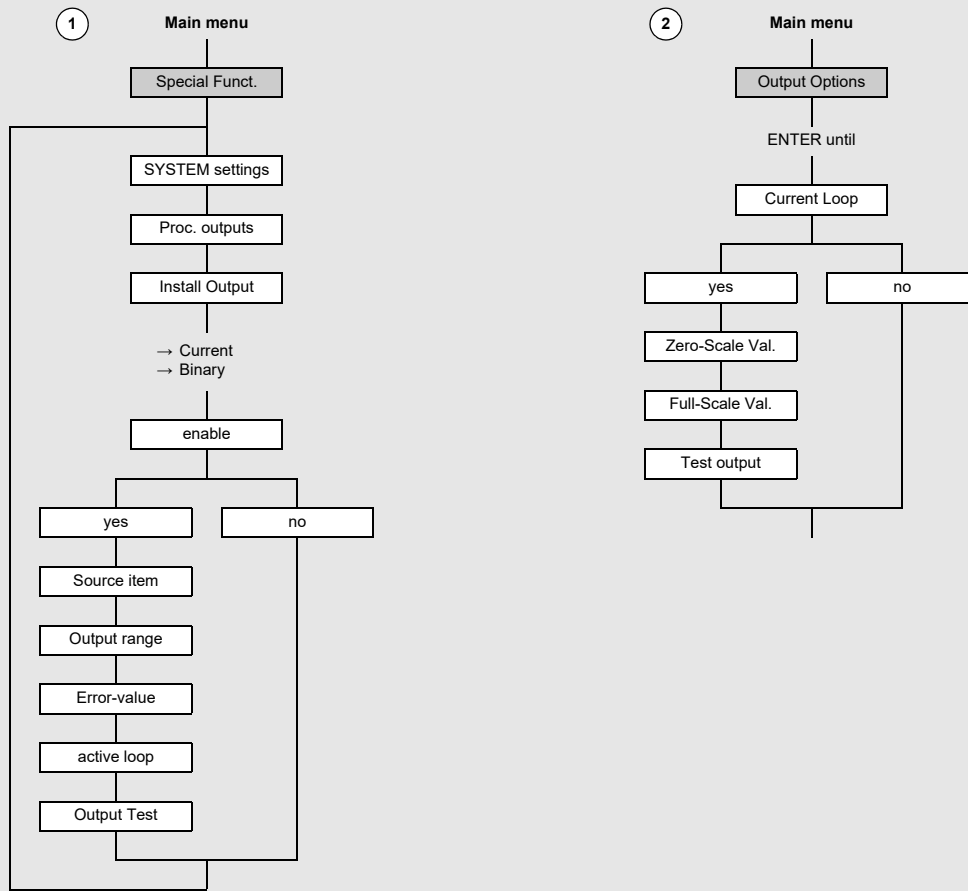

SuperUser mode

(see chapter 17)

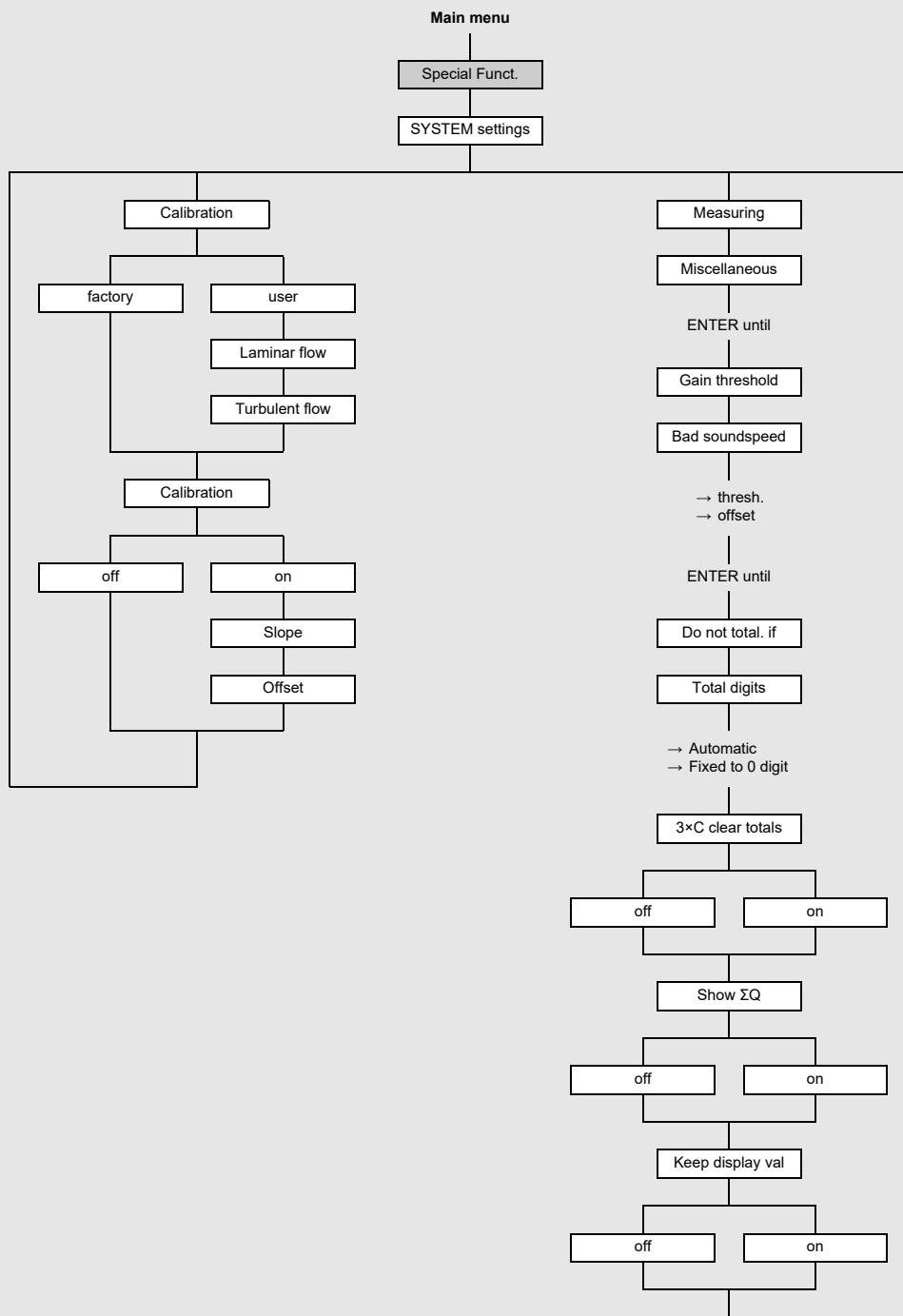

Alarm output

(see chapter 16)

1

Main menu

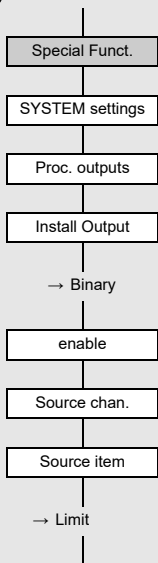

2

Main menu

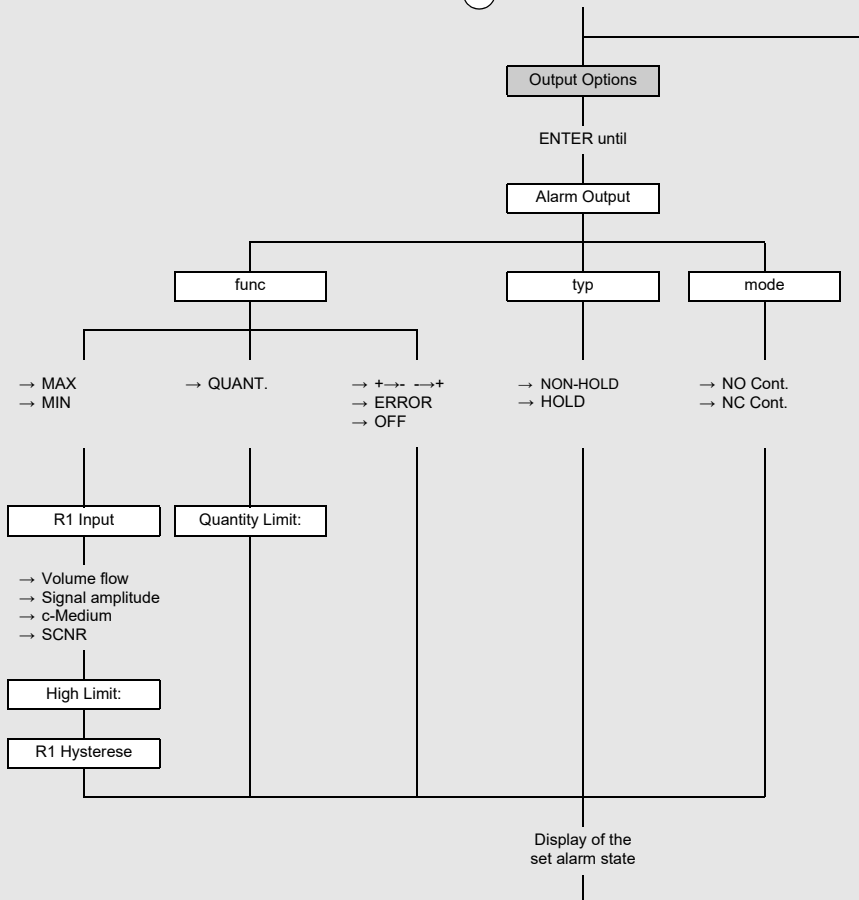

B Units of measurement

Length/roughness

| unit of measurement | description |
|---------------------|-------------|
| mm | millimeter |
| inch | inch |

Temperature

| unit of measurement | description |
|---------------------|-------------------|
| °C | degree Celsius |
| °F | degree Fahrenheit |

Pressure

| unit of measurement | description |
|---------------------|----------------------------------|
| bar(a) | bar (absolute) |
| bar(g) | bar (relative) |
| psi(a) | pound per square inch (absolute) |
| psi(g) | pound per square inch (relative) |

Density

| unit of measurement | description |
|---------------------|-------------------------------|
| g/cm ³ | gram per cubic centimeter |
| kg/cm ³ | kilogram per cubic centimeter |

Sound speed

| unit of measurement | description |
|---------------------|------------------|
| m/s | meter per second |

Kinematic viscosity

| unit of measurement | description |
|---------------------|------------------------------|
| mm ² /s | square millimeter per second |

1 mm²/s = 1 cSt

Flow velocity

| unit of measurement | description |
|---------------------|-----------------------|
| m/s | meter per second |
| cm/s | centimeter per second |
| inch/s | inch per second |
| fps (ft/s) | foot per second |

Volumetric flow rate

| unit of measurement | description | volume (totalized) |
|---------------------|-----------------------------|--------------------|
| m ³ /d | cubic meter per day | m ³ |
| m ³ /h | cubic meter per hour | m ³ |
| m ³ /min | cubic meter per minute | m ³ |
| m ³ /s | cubic meter per second | m ³ |
| km ³ /h | cubic kilometer per hour | km ³ |
| ml/min | milliliter per minute | l |
| l/h | liter per hour | l |
| l/min | liter per minute | l |
| l/s | liter per second | l |
| hl/h | hectoliter per hour | hl |
| hl/min | hectoliter per minute | hl |
| hl/s | hectoliter per second | hl |
| MI/d (megaliter/d) | megaliter per day | MI |
| bb/d | barrel per day | bbbl |
| bb/h | barrel per hour | bbbl |
| bb/m | barrel per minute | bbbl |
| bb/s | barrel per second | bbbl |
| USgpd (US-gal/d) | gallon per day | gal |
| USgph (US-gal/h) | gallon per hour | gal |
| USgpm (US-gal/m) | gallon per minute | gal |
| USgps (US-gal/s) | gallon per second | gal |
| KGPM (US-Kgal/m) | kilogallon per minute | kgal |
| MGD (US-Mgal/d) | million gallons per day | Mgal |
| IGPD (UK-gal/d) | gallon per day | lgal |
| CFD | cubic foot per day | cft ⁽¹⁾ |
| CFH | cubic foot per hour | cft |
| CFM | cubic foot per minute | cft |
| CFS | cubic foot per second | aft ⁽²⁾ |
| MMCFD | million cubic feet per day | MMCF |
| MMCFH | million cubic feet per hour | MMCF |

⁽¹⁾ cft: cubic foot

⁽²⁾ aft: acre foot

1 US-gal = 3.78541 l

1 UK-gal = 4.54609 l

1 bbl = US Oil ≈ 159 l

1 bbl = US Wine ≈ 119 l

1 bbl = US Beer ≈ 117 l

1 bbl = UK ≈ 164 l

Mass flow rate

| unit of measurement | description |
|---------------------|----------------------|
| t/h | ton per hour |
| t/d | ton per day |
| kg/h | kilogram per hour |
| kg/min | kilogram per minute |
| kg/s | kilogram per second |
| g/s | gram per second |
| lb/d | pound per day |
| lb/h | pound per hour |
| lb/m | pound per minute |
| lb/s | pound per second |
| klb/h | kilopound per hour |
| klb/m | kilopound per minute |

| mass (totalized) |
|------------------|
| t |
| t |
| kg |
| kg |
| kg |
| g |
| lb |
| lb |
| lb |
| lb |
| klb |
| klb |

1 lb = 453.59237 g

1 t = 1000 kg

C Reference

The following tables provide assistance for the user. The accuracy of the data depends on the composition, temperature and processing of the material. FLEXIM does not assume liability for any inaccuracies.

C.1 Sound speed of selected pipe and lining materials at 20 °C

The values of some of these materials are stored in the internal database of the transmitter. Column c_{flow} shows the sound speed (longitudinal or transversal) used for the flow measurement.

| material (display) | explanation | c_{trans} [m/s] | c_{long} [m/s] | c_{flow} |
|--------------------|--------------------------------|--------------------------|-------------------------|-------------------|
| Carbon Steel | steel, normal | 3230 | 5930 | trans |
| Stainless Steel | steel, stainless | 3100 | 5790 | trans |
| DUPLEX | duplex stainless steel | 3272 | 5720 | trans |
| Ductile Iron | ductile iron | 2650 | - | trans |
| Asbestos Cement | asbestos cement | 2200 | - | trans |
| Titanium | titanium | 3067 | 5955 | trans |
| Copper | copper | 2260 | 4700 | trans |
| Aluminium | aluminum | 3100 | 6300 | trans |
| Brass | brass | 2100 | 4300 | trans |
| Plastic | plastic | 1120 | 2000 | long |
| GRP | glass reinforced plastic (GRP) | - | 2650 | long |
| PVC | polyvinyl chloride | - | 2395 | long |
| PE | polyethylene | 540 | 1950 | long |
| PP | polypropylene | 2600 | 2550 | trans |
| Bitumen | bitumen | 2500 | - | trans |
| Acrylic | acrylic glass | 1250 | 2730 | long |
| Lead | lead | 700 | 2200 | long |
| Cu-Ni-Fe | copper-nickel-iron alloy | 2510 | 4900 | trans |
| Grey Cast Iron | gray cast iron | 2200 | 4600 | trans |
| Rubber | rubber | 1900 | 2400 | trans |
| Glass | glass | 3400 | 5600 | trans |
| PFA | perfluoralcoxy | 500 | 1185 | long |
| PVDF | polyvinylidene fluorid | 760 | 2050 | long |
| Sintimid | Sintimid | - | 2472 | long |
| Teka PEEK | Teka PEEK | - | 2534 | long |
| Tekason | Tekason | - | 2230 | long |

The sound speed depends on the composition and the manufacturing process of the material. The sound speed of alloys and cast materials fluctuates strongly. The values only serve as an orientation.

C.2 Typical roughness values of pipes

The values are based on experience and measurements.

| material | absolute roughness [mm] |
|---|-------------------------|
| drawn pipes of non-ferrous metal, glass, plastics and light metal | 0...0.0015 |
| drawn steel pipes | 0.01...0.05 |
| fine-planed, polished surface | max. 0.01 |
| planed surface | 0.01...0.04 |
| rough-planed surface | 0.05...0.1 |
| welded steel pipes, new | 0.05...0.1 |
| after long use, cleaned | 0.15...0.2 |
| moderately rusted, slightly encrusted | max. 0.4 |
| heavily encrusted | max. 3 |
| cast iron pipes: | |
| bitumen lining | > 0.12 |
| new, without lining | 0.25...1 |
| rusted | 1...1.5 |
| encrusted | 1.5...3 |

C.3 Properties of water at 1 bar and at saturation pressure

| fluid temperature [°C] | fluid pressure [bar] | sound speed [m/s] | density [kg/m ³] | specific heat capacity ¹ [kJ/kg/K ⁻¹] |
|---------------------------|-------------------------|----------------------|---------------------------------|---|
| 0.1 | 1,013 | 1402.9 | 999.8 | 4,219 |
| 10 | 1,013 | 1447.3 | 999.7 | 4,195 |
| 20 | 1,013 | 1482.3 | 998.2 | 4,184 |
| 30 | 1,013 | 1509.2 | 995.6 | 4,180 |
| 40 | 1,013 | 1528.9 | 992.2 | 4,179 |
| 50 | 1,013 | 1542.6 | 988.0 | 4,181 |
| 60 | 1,013 | 1551.0 | 983.2 | 4,185 |
| 70 | 1,013 | 1554.7 | 977.8 | 4,190 |
| 80 | 1,013 | 1554.4 | 971.8 | 4,197 |
| 90 | 1,013 | 1550.5 | 965.3 | 4,205 |
| 100 | 1,013 | 1543.2 | 958.3 | 4,216 |
| 120 | 1,985 | 1519.9 | 943.1 | 4,244 |
| 140 | 3,615 | 1486.2 | 926.1 | 4,283 |
| 160 | 6,182 | 1443.2 | 907.4 | 4,335 |
| 180 | 10.03 | 1391.7 | 887.0 | 4,405 |
| 200 | 15.55 | 1332.1 | 864.7 | 4,496 |
| 220 | 23.20 | 1264.5 | 840.2 | 4,615 |
| 240 | 33.47 | 1189.0 | 813.4 | 4,772 |
| 260 | 46.92 | 1105.3 | 783.6 | 4,986 |
| 280 | 64.17 | 1012.6 | 750.3 | 5,289 |
| 300 | 85.88 | 909.40 | 712.1 | 5,750 |
| 320 | 112.8 | 793.16 | 667.1 | 6,537 |
| 340 | 146.0 | 658.27 | 610.7 | 8,208 |
| 360 | 186.7 | 479.74 | 527.6 | 15.00 |
| 373,946 | 220,640 | 72,356 | 322.0 | ∞ |

¹ at constant pressure

D Conformity declarations

We,

FLEXIM Flexible Industriemesstechnik GmbH
Boxberger Straße 4
12681 Berlin
Germany,



declare under our sole responsibility that the transmitters

FLUXUS ADM 5x07, F501

to which this declaration relates are in conformity with the following EU directives:

- EMC Directive 2014/30/EU for Electromagnetic Compatibility
- Low Voltage Directive 2014/35/EU for Electrical Safety
- Directive 2011/65/EU of the European Parliament and of the Council of 8 June 2011 on the restriction of the use of certain hazardous substances in electrical and electronic equipment
- Commission Delegated Directive (EU) 2015/863 of 31 March 2015 amending Annex II to Directive 2011/65/EU of the European Parliament and of the Council as regards the list of restricted substances

The transmitters are in conformity with the following European standards when used with the FLEXIM transducers and accessories:

| EU directive | Class | Standard | Description |
|---------------|-------------------------|---------------------------------------|--|
| EMC Directive | - Immunity | EN 61326-1:2013 | Electrical equipment for measurement, control and laboratory use – EMC requirements – General requirements |
| | | EN 61326-1:2013 | Electrical equipment for continuous, unattended operation intended to be used in an industrial electromagnetic environment |
| | | EN 61000-4-2:2009 | Electromagnetic compatibility (EMC) – Testing and measurement techniques – Electrostatic discharge immunity test |
| | | EN 61000-4-3:2006 + A1:2008 + A2:2010 | Electromagnetic compatibility (EMC) – Testing and measurement techniques – Radiated, radio-frequency, electromagnetic field immunity test |
| | | EN 61000-4-4:2004 + A1:2010 | Electromagnetic compatibility (EMC) – Testing and measurement techniques – Electrical fast transient/burst immunity test |
| | | EN 61000-4-5:2006 | Electromagnetic compatibility (EMC) – Testing and measurement techniques – Surge immunity test |
| | | EN 61000-4-6:2009 | Electromagnetic compatibility (EMC) – Testing and measurement techniques – Immunity to conducted disturbances, induced by radio-frequency fields |
| | | EN 61000-4-11:2004 | Electromagnetic compatibility (EMC) – Testing and measurement techniques – Voltage dips, short interruptions and voltage variations immunity tests |
| | | - Emission | EN 61326-1:2013 |
| | EN 55011:2009 + A1:2010 | | Industrial, scientific and medical equipment – Radio-frequency disturbance characteristics – Limits and methods of measurement |

| EU directive | Class | Standard | Description |
|-----------------------|------------------------------|---------------------|--|
| Low Voltage Directive | Equipment Safety Requirement | EN 61010-1:2010 | Safety requirements for electrical equipment for measurement, control, and laboratory use – General requirements |
| | | EN 61010-2-030:2010 | Safety requirements for electrical equipment for measurement, control, and laboratory use – Particular requirements for testing and measuring circuits |
| | - Insulation | EN 61010-1:2010 | Pollution degree 2 Overvoltage category 2 Safety class 1 |

The installation, operating and safety instructions have to be observed!

Berlin, 2019-07-22



Dipl.-Ing. Jens Hilpert
Managing Director